



# LifePod<sup>®</sup> 2.0

INSTRUCTION MANUAL

**QUICK SETUP!**

**SCAN CODE** →

\*USE PHONE CAMERA



or visit [www.vaulteksafe.com/support/](http://www.vaulteksafe.com/support/)

## Warnings

To prevent damage to your Vaultek® unit or injury to yourself or to others, read the following safety precautions before using this unit.

**Change the default code as soon as possible to prevent unauthorized access to your safe.**

Before locking your LifePod®, always make sure the side compression latches are latched closed first. This will ensure the locking mechanism engages properly.

**DO NOT** place or store the backup keys inside the LifePod® at any time. If the battery fails, you will be unable to open the LifePod®.

**DO NOT** store loaded guns in this unit. Firearms are serious in nature and must be handled with respect. Store responsibly.

**DO NOT** use a battery which has physical damage such as scratches and dents on the housing.

**DO NOT** expose to extreme heat or cold. Battery power may be affected. Acceptable operation range is -14°f to 120°f.

No case or lock is impenetrable given the right skills and tools. For protection against lock picking, see the anti-picking feature on page 17.

**Keep this product away from small children as the package contains small items that could become a choking hazard.**

Further warnings and disclaimers on next page.

LifePod® is designed to protect against dust and splashes with brief short immersions and will float when loaded with weight up to 2lb.

LifePod® can be submerged to 1 foot up to 30 minutes.

**To ensure proper weather sealing:**

**ALWAYS** check that the rubber gasket is free of debris before closing the lid.

**ALWAYS** check that the side compression latches are fully engaged and closed.

**ALWAYS** check that the front rubber cover is closed tightly.

**Disclaimers:**

NEITHER SELLER NOR MANUFACTURER SHALL BE LIABLE FOR ANY INJURY, LOSS OR DAMAGE, DIRECT OR CONSEQUENTIAL, ARISING OUT OF THE USE OF, OR THE INABILITY TO USE, THE VAULTEK® LIFEPOD®.

THE USER SHALL DETERMINE THE SUITABILITY OF THE VAULTEK® LIFEPOD® BEFORE THE INTENDED USE AND USER ASSUMES ALL RISK AND LIABILITY WHATSOEVER IN CONNECTION THEREWITH.

## Table of Contents

At Vaultek® we stand behind our product and you our customer. On behalf of the entire team thank you for your purchase. We believe personal defense should be handled seriously and we're excited for you to experience the ultimate performance in smart-security.

### Quick Start Guide

- Step 1** Battery Installation (05)
- Step 2** Master Code Programming (07)
- Step 3** Biometric Scanner Programming (09)
- Step 4** Product Registration (19)

### Box Contents

- LifePod® 2.0
- Manual/Quick Start Guide
- Steel Security Cable

01 / 02	Get to Know Your LifePod®	12	- Deleting Fingerprints
03 / 04	Basic Operations	12	- Low Success Rate
03	- Locking	13 / 14	LED Indicators
03	- Unlocking	15	Hot Keys to Control Sound and Light
05	Battery Installation	16	Compression Latches
06	Battery Maintenance	17	Anti-Picking
06	Using the Micro-USB Port	18	Securing your LifePod®
07 / 08	Master Code Programming	18	Removable Interior Tray
09 / 12	Biometric Scanner	19	Product Registration
10	- Programming Admin Prints 1 and 2	20	Troubleshooting
11	- Programming Prints 3-20	21	<b>Customer Support / Warranty</b>

## Get to Know Your LifePod® 2.0

The Vaultek® LifePod® 2.0 is a pin access portable lockbox. It can be secured using the side compression latches to protect the interior from environmental factors such as water, with the added option of securely locking the unit with the keypad. It's high impact polymer and portable design makes it ideal to transport and protect valuables and personal items. Powered by an Alkaline 9V battery (not included), LifePod® combines security with convenient access.

- 01. Capacitive Keypad
- 02. Side Compression Latches
- 03. Battery Cover
- 04. Anti-Picking Switch
- 05. Program Button
- 06. Interior LED
- 07. Anti-Impact Latch
- 08. Removable Tray
- 09. Biometric Scanner (Only Biometric Model)
- 10. Keyhole/Micro-USB Cover
- 11. Steel Security Cable

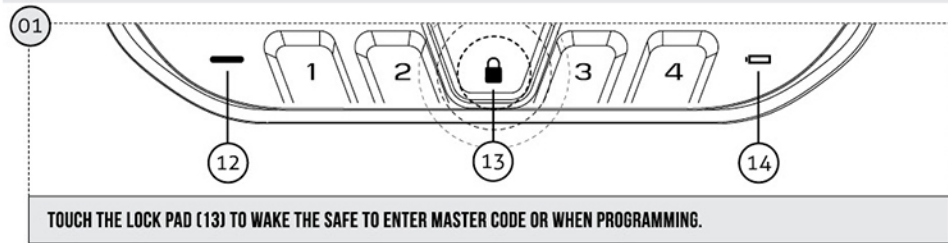
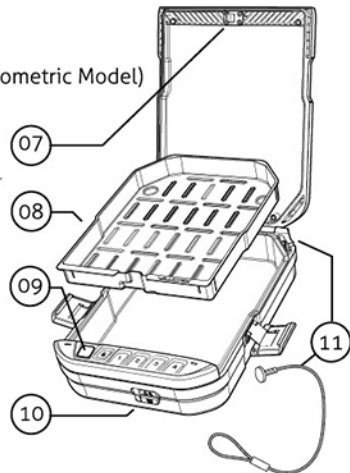
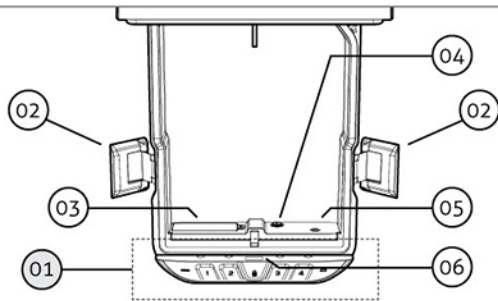

**TOUCH THE LOCK PAD (13) TO WAKE THE SAFE TO ENTER MASTER CODE OR WHEN PROGRAMMING.**

LifePod's capacitive keypad has multiple LEDs built in to provide various feedback. The LEDs will illuminate as needed when the unit is awake. To wake the unit, tap the lock pad.

- 12. Status LED
- 12. Tamper Indication

- 13. Lock Pad
- 14. Battery Indicator

- 14. Low Battery Warning

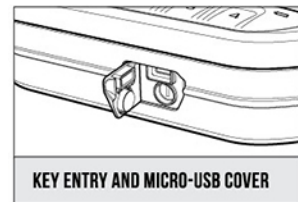

**KEY ENTRY AND MICRO-USB COVER**

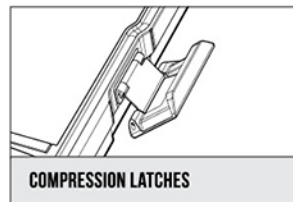

**COMPRESSION LATCHES**

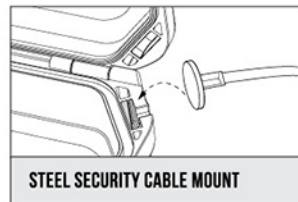

**STEEL SECURITY CABLE MOUNT**

## Basic Operation: Locking

With a 9V battery installed, you can now lock your LifePod® safe. To lock, simply press and hold the lock pad for 2 seconds (Fig A).

**Tip!** Your LifePod® can protect your belongings against the elements using the side compression latches alone. For extra security, lock the unit with the lock pad as needed.

**IMPORTANT!** Before locking your LifePod®, always be sure the side compression latches are latched closed first. This will ensure the locking mechanism engages properly.

## Basic Operation: Unlocking

With a 9V battery installed, you can now unlock your LifePod® safe.

**IMPORTANT!** Do not undo the compression latches until the unit has been unlocked using one of the authorized access points. Undoing the compression latches first may cause binding on the lock mechanism and will not unlock.

**Master Code:** Touch activated 4-digit backlit LED capacitive keypad.

First tap the lock pad to wake the unit up. When the keypad lights up, your LifePod® is awake and ready to accept the code. Enter your master code. When the code is correct, the status LED will turn GREEN and the lock will disengage. Default master code is 1-2-3-4.

**IMPORTANT!** Before entering your master code or when programming you need to wake the safe by placing your finger on the lock pad (Fig A) so all the keys light up RED.

**Backup Keys:** Included backup manual keys are provided to unlock the unit if the battery dies.

To unlock LifePod®, simply open the protective cover at the front of LifePod® (Fig 10 on page 01), insert one of the backup keys, and turn the key clockwise 90 degrees. If the Anti-Picking feature is enabled, the backup keys can not open LifePod®. See page 17 for details.

**IMPORTANT!** Always make sure the front protective cover is closed tightly to ensure the unit is sealed correctly for protection from the elements.

**IMPORTANT!** The manual key can not lock LifePod®.

**Biometric Scanner (Biometric Model Only):** Capable of storing up to 20 unique fingerprints.

Simply scan an authorized fingerprint to unlock LifePod®. No need to wake up LifePod®. When the scan is authorized, the status LED will turn GREEN and the lock will disengage. Your safe can store 20 unique fingerprint IDs. The 1st and 2nd fingerprints will be recognized as administrative fingerprints and will be used to authorize additional users (3-20).

**Security Sleep Mode:** Activates when (6) consecutive incorrect keypad or fingerprint entries (biometric model) are entered. LifePod® will not accept any entries for four minutes. If a key is pressed during this time, the status LED will flash RED and the alarm beeps. A backup key can be used to open the unit.

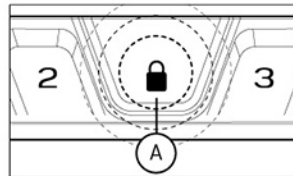

## Battery Installation

LifePod® is powered by a 9v Alkaline battery (not included). Under normal use the battery can last up to one year.

- 1 Undo both side compression latches to open your LifePod®.
- 2 Locate the battery cover on the front wall and remove by pressing on the outer tab (Fig B).
- 3 Pull out the 9v battery snap inside the battery compartment, and connect an Alkaline 9V battery to the connector. Be sure to snap the battery in the correct orientation (Fig C).
- 4 When the battery is snapped in you will hear a short welcome tone and the keypad will light up.

**Troubleshooting!** If you snap the battery in and the keypad is flashing then your battery is likely low. Replace the battery with a new 9v Alkaline battery. We recommend a brand name battery like Duracell or Energizer.

- 5 Once you hear the tone and see the keypad light up, slide the battery into its compartment being mindful to place the battery ribbon underneath the battery first (Fig D). This will make the battery easier to remove when replacing.

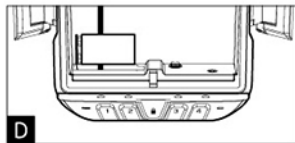
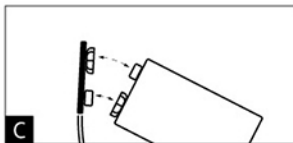
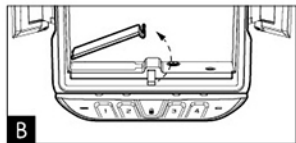

## Battery Maintenance

### Battery Maintenance: Testing the Battery Power

To check the battery level, tap the lock pad. The battery indicator (Fig E) will glow GREEN to indicate sufficient battery level or RED to indicate that the battery is in need of replacement.

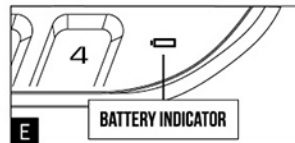

### Battery Maintenance: Low Battery Warning

The battery indicator (Fig E) will flash RED and sound several rapid beeps. This continues every 5 minutes until the battery dies to indicate the battery is in need of a replacement.

**IMPORTANT!** Do not use a battery which has physical damage such as scratches and dents on the housing.

## Using the Micro-USB Port

In the event the battery dies while traveling, and you do not have access to the backup keys, you can power on the unit using the backup micro-USB port.

Simply open the front protective rubber cover behind (Fig F) and plug in a micro-USB cable (not included) into the port. While the cable is plugged into an external power source, LifePod® will function normally allowing you to enter the code and open the unit.

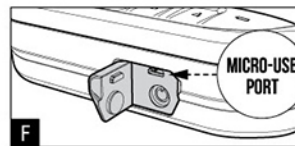

## Master Code Programming

**WARNING!** First time users should change the default code as soon as possible to prevent unauthorized access when using the lock.

### Code Requirements

- Your code can be a minimum of 4 digits, or as long as 8 digits. We recommend a code 6 to 8 digits in length using at least one of each key to make it more difficult for someone to guess your code.
- Avoid easy-to-guess digits such as 1234, 1111, 2222, etc.
- Two keys can not be pressed simultaneously.
- Programming a new code will overwrite your previous code.
- The default master code is 1-2-3-4.

**Security Sleep Mode:** Activates when (6) consecutive incorrect keypad or fingerprint entries (biometric model) are entered. LifePod® will not accept any entries for four minutes. If a key is pressed during this time, the status LED will flash RED and the alarm beeps. A backup key can be used to open the unit.

For setup, tutorials, and FAQs visit [www.vaulteksafe.com/support/](http://www.vaulteksafe.com/support/)

**IMPORTANT!** The PROGRAM button will not function when locked. Be sure the LifePod® latch is in the unlocked position.

- 1 First open the unit and tap the lock pad to wake the unit up (Fig G). When the keypad lights up, your LifePod® is awake and ready for programming.
- 2 While LifePod® is awake press and hold the PROGRAM button for 3 seconds (Fig H) until ALL keys (1-4) turn solid RED.
- 3 Enter your new code. Immediately press and hold the PROGRAM button a second time for 3 seconds (Fig H) until ALL keys (1-4) turn solid RED.
- 4 Enter your new code a second time. Immediately press and hold the PROGRAM button a third time for 3 seconds (Fig H). The status LED (Fig I) will flash GREEN and LifePod® will beep to confirm the code change is successful.

**Troubleshooting!** If you make a mistake start over with step 1.

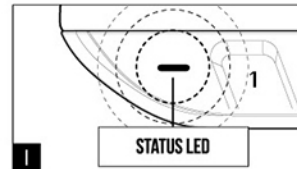
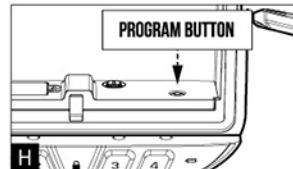
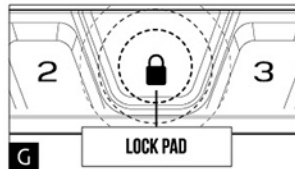

## Biometric Scanner: Overview (Biometric Model Only)

The safe is capable of storing fingerprint data for up to 20 unique authorized users. A user consists of 4 scans of the same finger during registration. Once a user's fingerprint data is stored in the safe and encrypted, it cannot be copied or stolen. The 1st and 2nd fingerprints will be recognized as administrative fingerprints and are required to authorize enrolling additional users (3-20).

### Helpful Programming Tips!

- **Place the core of the fingerprint flat** (Fig J + K + L) over the center of the scanner (this allows the scanner to read where most of the fingerprint detail is located) see (Fig J).
- Rotate your finger slightly between registration scans to store print variations for increased accuracy (Fig L).
- Excessive moisture, lotions, or dirt will affect your fingerprint and may cause inaccurate sensor reading.
- **Troubleshooting!** If you are having difficulty with your print, program the same fingerprint 4 or 5 times. You have 20 slots available for programming and you can also try your thumb as it has more surface area to read.

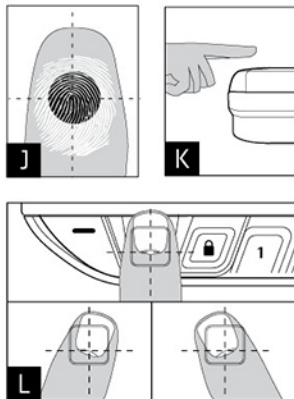

**Usage Tip!** The scanner is waterproof just like the LifePod®. However, if the scanner is wet it needs to be dried off before a finger is scanned.

## Biometric Scanner: Programming Admin Print 1 and 2

The 1st and 2nd fingerprints will be recognized as administrative fingerprints and are required to authorize enrolling additional users (3-20). To program additional users refer to the next page.

- 1 First open the unit and tap the lock pad to wake the unit up (Fig G page 08). When the keypad lights up, your LifePod® is awake and ready for programming. Programming each fingerprint takes 4 registration scans.
- 2 Registration Scan 1: While LifePod® is awake, quickly tap the program button (Fig H on page 08) to get the 1 key blinking. Place your finger on the scanner and remove it when the status LED (Fig I on page 08) turns GREEN and you hear a confirmation beep.
- 3 Registration Scan 2: With the 2 key now blinking, place same finger on the scanner at a slightly different angle and remove it when the status LED turns GREEN and you hear a confirmation beep.
- 4 Registration Scan 3: With the 3 key now blinking, place same finger on the scanner at a slightly different angle and remove it when the status LED turns GREEN and you hear a confirmation beep.
- 5 Registration Scan 4: With the 4 key now blinking, place same finger on the scanner at a slightly different angle and remove it when the status LED turns GREEN and you hear a confirmation beep. **This completes enrollment for the first admin print.**

**Tip!** Repeat steps 1-5 to enroll the 2nd admin print. To program prints (3-20) refer to page 11.

**Tip!** Simply scan an authorized fingerprint to unlock LifePod®. No need to wake up LifePod®.

**Troubleshooting!** Reference the troubleshooting tip on page 09.



## Biometric Scanner: Programming Additional Prints 3-20

With both admin prints enrolled, you can enroll additional users. This safe can store up to a total of 20 different fingerprints.

- 1 Open the safe lid, and wake LifePod® by tapping the lock pad so all the keys light up RED. While LifePod® is awake, quickly tap the program button to get keypad flashing RED. This is prompting the scan of an admin print to authorize the request to enroll a new user. Scan one of the enrolled admin prints to authorize enrolling a new user.
- 2 Registration Scan 1: With the 1 key now blinking, place the new finger on the scanner and remove it when the status LED turns GREEN and you hear a confirmation beep.
- 3 Registration Scan 2: With the 2 key now blinking, place the same finger on the scanner at a slightly different angle and remove it when the status LED turns GREEN and you hear a confirmation beep.
- 4 Registration Scan 3: With the 3 key now blinking, place the same finger on the scanner at a slightly different angle then remove it when the status LED turns GREEN and you hear a confirmation beep.
- 5 Registration Scan 4: With the 4 key now blinking, place the same finger on the scanner at a slightly different angle then remove it when the status LED turns GREEN and you hear a confirmation beep. This completes enrollment for a new single user.

**Tip!** Repeat steps 1-5 to enroll additional prints.

Continue on next page to learn how to delete fingerprints.

## Biometric Scanner: Deleting Fingerprints

To delete all the stored prints on the LifePod®, wake the unit by tapping the lock pad so all the keys light up RED. Immediately, press and hold keys '1' and '3' together for 3 seconds (until all the keys turn RED) then enter your master code to delete all fingerprint IDs.

## Biometric Scanner: Low Success Rate

If you are having difficulty with your print, program the same fingerprint 4 or 5 times. You have 20 slots available for programming and you can also try your thumb as it has more surface area to read.

First delete the fingerprints and start over. Wake the unit up by tapping the Lock Pad so all the keys light up RED. Immediately, press and hold keys 1 and 3 together for 3 seconds (until all the keys turn RED) then enter your master code to delete all fingerprint IDs.

Then reprogram your fingerprint using the helpful tips on page 09.

For setup, tutorials, and FAQs visit [www.vaulteksafe.com/support/](http://www.vaulteksafe.com/support/)

## LED Indicators

LifePod's capacitive keypad has multiple LEDs built in to provide various feedback. The LEDs will illuminate as needed when the unit is awake. To wake the unit, tap the lock pad.

**Status LED** (Fig M) The status LED will provide feedback on various commands. It will light GREEN when correct codes are entered or an authorized fingerprint is scanned (biometric model) and RED when an incorrect code is entered or an unauthorized fingerprint is scanned.

**Tamper Indication** (Fig M) If the status LED is solid RED when awake, this means the unit has detected that an incorrect code has been entered or an unauthorized fingerprint has been scanned (biometric model). You can clear the tamper indicator by entering the correct master code or scanning an authorized fingerprint.

**Battery Indicator** (Fig O) When the unit is awake, the battery indicator will light either GREEN or RED. Green indicates the battery has sufficient power, and Red indicates the battery is in need of replacement.

**Low Battery Warning** (Fig O) The battery indicator will flash RED and sound several rapid beeps. This continues every 5 minutes until the battery dies to indicate the battery is in need of a replacement.

**Lock Pad** (Fig N) The lock pad illuminates RED only when the unit has been locked using the keypad, and requires the use of the master code or fingerprint scanner (biometric model) to unlock it. When locked, and the unit is awake, the lock icon will be solid RED.

NON-BIOMETRIC LIFEPOD® 2.0

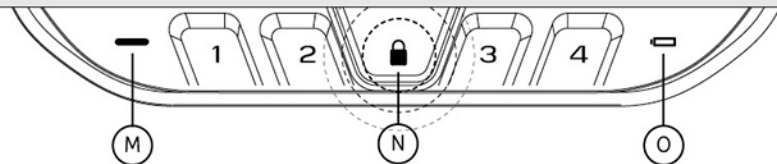

BIOMETRIC LIFEPOD® 2.0

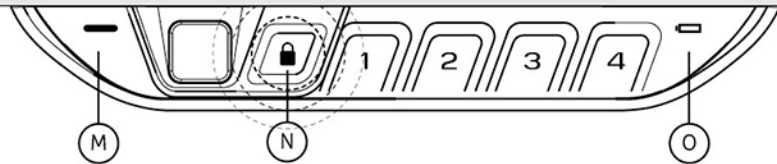

**Tip!** If the lock icon is solid RED, do not undo the side compression latches to open the unit. This means the internal lock is engaged and should not be opened. Enter the master code or scan a fingerprint (biometric model) to unlock the unit, as indicated by the lock icon light going OFF. It is now safe to undo the side latches and open the unit.

## Hot Keys to Control Sound and Light

**Toggle Interior LED Light ON/OFF:** The Interior LED light will come on when the lid is open and stays on for about 20 seconds by default. You have the option to disable the light, or extend the light to stay on longer. To toggle the interior LED light options you need to wake up LifePod® by tapping the center Lock Pad then press and hold keys '1' and '4' together. The status LED will indicate the selected light setting per below:

**Tip!** If toggled ON the LED may significantly reduce the battery life.

**Status LED Solid RED:** Interior Light is Off

**Status LED Solid GREEN:** Interior Light stays on for 20 seconds.

**Status LED Flashing Green:** Interior Light stays on for 60 seconds.

**Toggle Sound ON/OFF:** By default, the sound is ON. To toggle the sound ON/OFF you need to wake up LifePod® by tapping the center Lock Pad then press and hold keys '2' and '3' together. The status LED will flash RED indicating OFF or GREEN indicating ON.

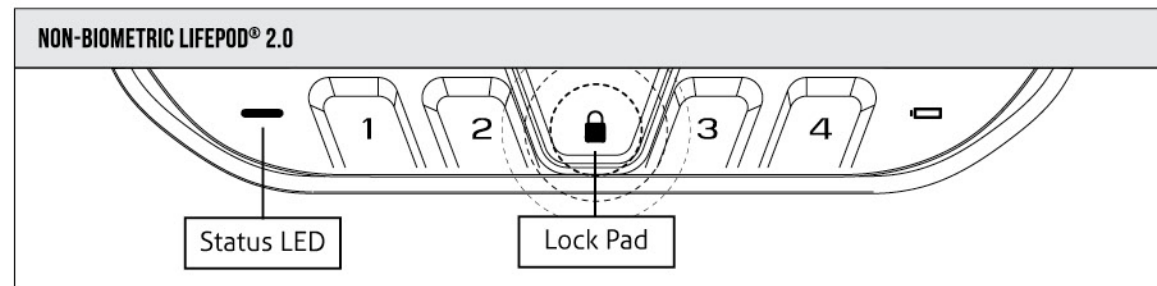

## Compression Latches

LifePod's side compression latches can protect belongings from environmental factors using the side latches alone without the need for a battery.

**To Open** simply lift from the bottom of each latch away from the unit (Fig P). The latches will lift and disengage, then swing the latches free of the unit (Fig Q). The top lid can now be opened.

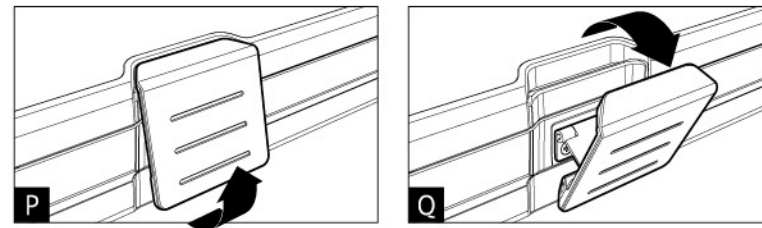

**To Close** rest the top of each latch against the top housing (Fig R). The latches will catch and rest in place on their own. Press the bottom of each latch firmly towards the unit to engage (Fig S). You will hear and feel the latches snap in position.

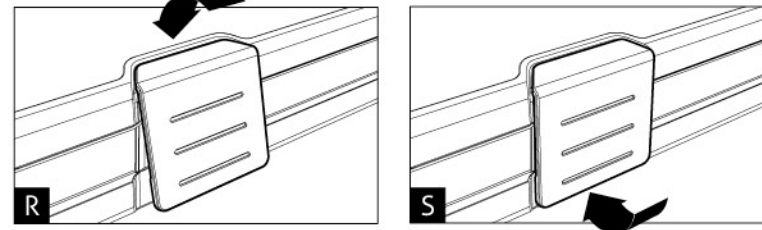

## Anti-Picking

Your LifePod® is equipped with an anti-hacking feature for enhanced security. Using the Anti-Picking feature, you can disable the front key access. This prevents the front keyway from being picked open, but also prevents the lock from being opened with the manual key.

**IMPORTANT!** The manual key can not lock LifePod® with either setting.

**OFF** (Fig T) Default setting. Front keyway is functional, manual keys can unlock LifePod®.

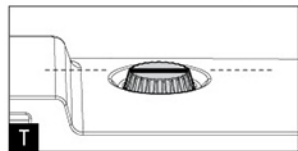

**ON** (Fig U) Front keyway is disabled. LifePod® can not be picked open, and the manual keys can not be used to open the unit.

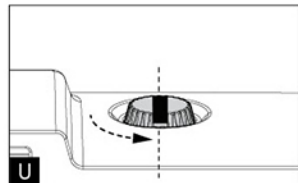

**WARNING** When Anti-Picking is ON, the backup keys will not be able to open the unit. Use with caution.

**WARNING** When Anti-Picking is ON, the backup keys will not be able to open the unit. If you forget your master code or fingerprint is not enrolled (biometric mode) you will be unable to open LifePod®. Use with caution.

## Securing your LifePod®

Included is a steel security cable to secure the LifePod® to a fixed object.

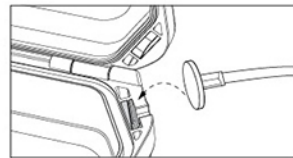
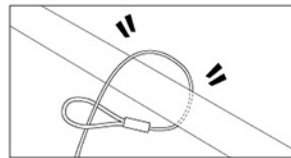
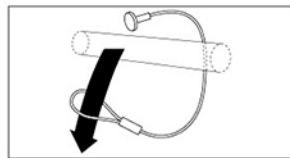

- 1** First wrap the looped end of the security cable an object of your choice, such as a seat bracket under your car seat.
- 2** Pull the adapter piece through the loop, and cinch tight.
- 3** Place the adapter piece in its slot in the LifePod®, and close the lid.

## Removable Interior Tray

LifePod® 2.0 is equipped with a removable interior tray. This can be used to divide the storage space and organize as needed, or can be removed if preferred when deeper storage space is needed.

The tray features a series of slots that can be used to secure and organize smaller items, such as EDC gear (Fig V).

Velcro straps (2x Velcro straps included) are attachment methods that you can use to secure belongings to the tray.



## Product Registration

Vaultek® strongly encourages you to register your LifePod® as soon as you receive it.

**Registration provides many benefits including two year warranty, technical support, and ordering replacement keys should you misplace them.** Your Vaultek® LifePod® has a unique product number on the inside of the battery door and a 5 or 6 digit ID number engraved on the keys. You will need these numbers to register your new unit.

- 1 Locate your product number. It is printed on the first page of this user manual and on the back of the battery door (Fig W).
- 2 Find your 5 or 6 digit ID number engraved on the keys (Fig X).
- 3 Please visit the Vaultek® website at [vaulteksafe.com](http://vaulteksafe.com) and click Support then click Registration from the available options.
- 4 Enter the required information in the form and click submit.

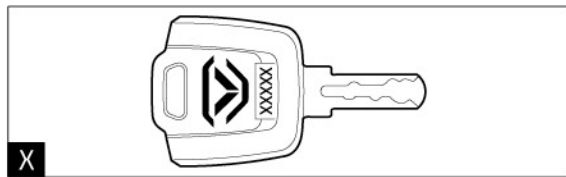
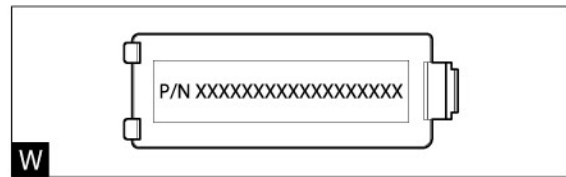

For setup, tutorials, and FAQs visit [www.vaulteksafe.com/support/](http://www.vaulteksafe.com/support/)

## Troubleshooting More online at [vaulteksafe.com](http://vaulteksafe.com) under Support

If you have any questions or issues please email [support@vaulteksafe.com](mailto:support@vaulteksafe.com).

**Keypad is Flashing RED:** The battery is likely bad. Test the normal function by removing the battery and plugging in a micro-USB cable to the micro-USB port. If the unit resumes normal function then the installed battery is bad.

**Keypad is Flashing RED When Programming Fingerprints:** This is prompting the scan of an admin print to authorize the request to enroll a new user. Scan one of the enrolled admin prints to authorize enrolling a new user, and then continue with the registration scans.

**Keys Can Not Lock LifePod®:** LifePod's backup keys are designed to unlock LifePod in the event the battery dies, but they can not lock LifePod®. NOTE: Enabling the Anti-picking feature will prevent the keys from being able to unlock LifePod® as this feature disables the front keyway.

**New Battery is Not Working:** Test normal function by removing the battery and plugging in a micro-USB cable to the micro-USB port to power the unit so you can unlock and replace the battery. We recommend a brand name battery like Duracell or Energizer.

**Low Fingerprint Success Rate:** If you are having difficulty with your print, program the same fingerprint 4 or 5 times. You have 20 slots available for programming and you can also try your thumb as it has more surface area to read. Refer to page 12 for more information.

**STOP!** Do not return to retailer. If you have any questions about your Vaultek® LifePod® or need help configuring the system, please email us at [support@vaulteksafe.com](mailto:support@vaulteksafe.com).

## Customer Support

If you have a problem with your Vaultek® LifePod® that is not answered in the troubleshooting section of this manual, we encourage you to visit [www.vaulteksafe.com/support/](http://www.vaulteksafe.com/support/) or email our support team at [support@vaulteksafe.com](mailto:support@vaulteksafe.com).

## Warranty (Terms and Conditions)

VAULTEK® IS COMMITTED TO PROVIDING PRODUCTS OF HIGH QUALITY AND VALUE AND MAKES EVERY EFFORT TO ENSURE ITS PRODUCTS ARE FREE OF DEFECTS.

Vaultek® guarantees your LifePod® will be free of defects in materials or workmanship for a period of one year from the date of original purchase from an authorized dealer and two years with product registration.

The warranty is only valid for the original purchaser and not transferable. This warranty is only valid for products purchased and operated in the U.S. This warranty does not cover abuse, misuse, use in any manner for which is not designed, neglected, modification, damage inadvertently caused by the user, accidents and/or tampering.

If service is needed Vaultek® will, at its option, exchange or repair without charge for parts or labor. Upon authorization of warranty service, customers are responsible for securely packaging product.

Additionally, customers are responsible for costs of shipping to and from Vaultek® service center.

If the claimed defect cannot be identified or reproduced, customers will be held responsible for the costs incurred. Please have the following information available before you begin a claim with Vaultek®:

- Purchaser's name, mailing address, email address, and a phone number.
- Copy of receipt or online order number (if purchased directly from us or Amazon)
- Authorized Dealer Name (if applicable)
- Detailed description of the problem

NEITHER SELLER NOR MANUFACTURER SHALL BE LIABLE FOR ANY INJURY, LOSS OR DAMAGE, DIRECT OR CONSEQUENTIAL, ARISING OUT OF THE USE OF, OR THE INABILITY TO USE THE VAULTEK® LIFEPOD®.

**FCC** This device complies with part 15 of the FCC rules. Operation is subject to the following two conditions: (1) this device may not cause harmful interference, and (2) this device must accept any interference received, including interference that may cause undesired operation. NOTE: The manufacturer is not responsible for any radio or TV interference caused by unauthorized modifications or changes to this equipment. Such modifications or changes could void the user's authority to operate the equipment.



**VAULTEK®**

624 Douglas Ave Suite 1412 Altamonte Springs, FL 32714

VAULTEKSAFE.COM

REV 032624