



Instruction Manual

LifePod® XR

QUICK SETUP!

SCAN CODE ▶

*USE PHONE CAMERA



or visit www.vaulteksafe.com/support/

Thank You

At Vaultek® we stand behind our product and you our customer. On behalf of the entire team thank you for your purchase. We believe personal defense should be handled seriously and we're excited for you to experience the ultimate performance in smart-security.

Access Quick Setup, Tutorials and Troubleshooting online using the code on the right. Simply scan the code with your phone's camera or visit www.vaulteksafe.com/support/ and select your model.

Need help? Please email our support team at support@vaulteksafe.com.

Stop! Do not return to retailer. If you have any questions about your Vaultek® safe or need help configuring the system, please visit www.vaulteksafe.com/support/.

Vaultek® Customer Support: support@vaulteksafe.com



Table of Contents

Quick Start Guide

- Step 1** Battery Installation (06)
- Step 2** Master Code Programming (08)
- Step 3** Biometric Scanner Programming (09)
- Step 4** Product Registration (17)

Box Contents

- Vaultek® LifePod® XR
- Steel Security Cable
- Owner's Manual
- Backup Keys (2)

01 / 02	Get to Know Your LifePod® XR	14	Hot Keys to Control Sound and Light
03 / 04	Basic Operations	15	Compression Latches
03	- Unlocking	16	Securing your LifePod® XR
04	- Locking	17	Product Registration
04	- How Your LifePod® XR Keeps People Out	18	FAQ
05	Warnings	19 / 20	Troubleshooting
06	Battery Installation	21	Customer Support
07	Using the Micro-USB Port	21	Warranty
07	Backup Manual Key		
08	Master Code Programming		
09 / 11	Biometric Scanner		
09	- Overview and Tips		
10	- Programming Admin Prints 1 and 2		
11	- Programming Additional Prints 3-20		
12	- Deleting Fingerprints		
12	- Low Success Rate		
13	LED Indicators		

For setup, tutorials, and FAQs visit www.vaulteksafe.com/support/ and select your model.

Important Usage Notes

Be sure to follow these notes for proper function.

Locking

- Step 1 Shut the lid and close compression latches.
- Step 2 Press and hold lock icon for 3 seconds.

Unlocking

- Step 1 **Unlock with master code/scanner first.**
- Step 2 **Undo the compression latches second.**

Tip! Do not undo the compression latches until the unit is unlocked.

Unlocking the unit while the compression latches are undone may cause **the locking mechanism to bind and the lid will not be able to open.**

If the lid does not open when unlocked, close both compression latches and unlock the unit again to free the lock mechanism.

Interior May Pressurize

Due to LifePod's airtight seal and pressure changes when shipping the lid can stick and be difficult to open.

If the lid does not open, release the pressure by opening the front keyhole cover and the lid can freely open.

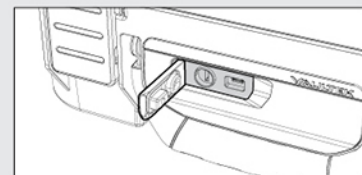

For setup, tutorials, and FAQs visit www.vaulteksafe.com/support/ and select your model.

Get to Know Your Vaultek® LifePod® XR

The Vaultek® LifePod® XR is a pin access portable lockbox. It can be secured using the side compression latches to protect the interior from environmental factors such as water, with the added option of securely locking the unit with the keypad. It's high impact polymer and portable design makes it ideal to transport and protect valuables and personal items. Powered by an Alkaline 9V battery (not included), XR combines security with convenient access.

- 01. Capacitive Keypad
- 02. Side Compression Latches
- 03. Keyhole/Micro-USB Cover
- 04. Interior LEDs
- 05. Battery Cover
- 06. Program Button
- 07. Accessory Slots
- 08. Steel Security Cable Mount
- 09. Anti-Impact Latches

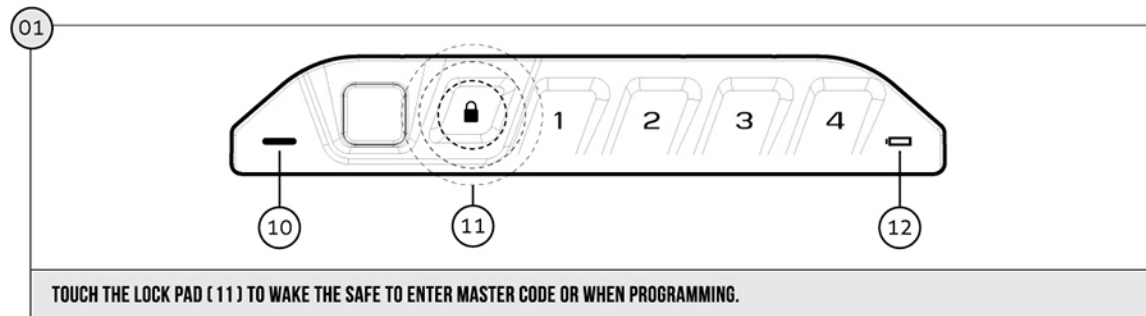
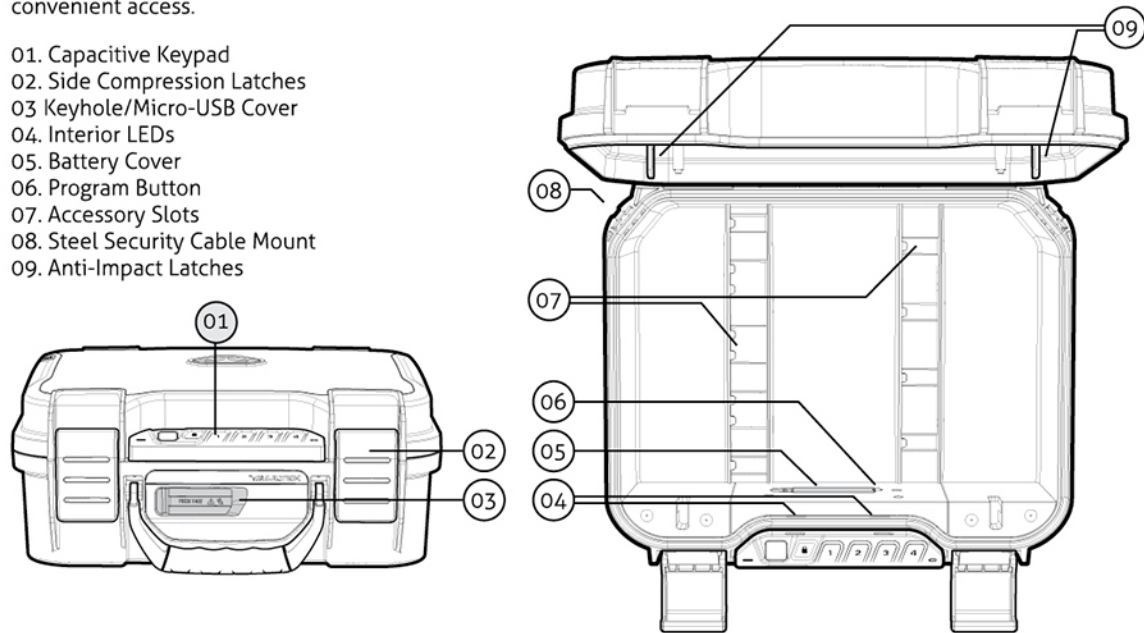

TOUCH THE LOCK PAD (11) TO WAKE THE SAFE TO ENTER MASTER CODE OR WHEN PROGRAMMING.

XR's capacitive keypad has multiple LEDs built in to provide various feedback. The LEDs will illuminate as needed when the unit is awake. To wake the unit, tap the lock pad.

- 10. Status LED
- 10. Tamper Indication

- 11. Lock Pad
- 12. Battery Indicator

- 12. Low Battery Warning

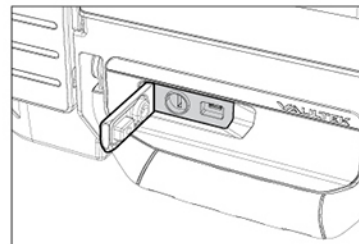

KEY ENTRY AND MICRO-USB COVER

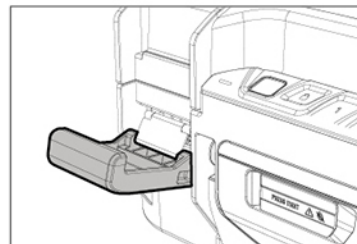

COMPRESSION LATCHES

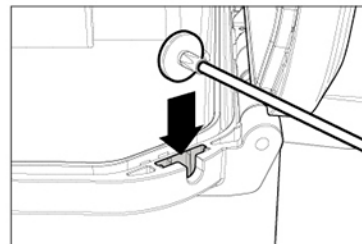

STEEL SECURITY CABLE MOUNT

Basic Operation: Unlocking

With a 9V battery installed, you can now unlock your LifePod® XR safe. Unique to LifePod® XR is a capacitive numeric keypad with built-in proximity sensor. Touch lock pad on the keypad to wake the safe before entering your master code.

IMPORTANT! Before entering your master code or when programming you need to wake the safe by placing your finger on the Lock Pad (Fig A) so all the keys light up RED.

IMPORTANT! Do not undo the compression latches until the unit has been unlocked with the correct master code first. Undoing the compression latches first may cause binding on the lock mechanism and will not unlock.

Master Code: Touch activated 4-digit backlit LED capacitive keypad.

First tap the lock pad to wake the unit up. When the keypad lights up, your LifePod® XR is awake and ready to accept the code. Enter your master code. When the code is correct, the Status LED will turn GREEN and the lock will disengage. Default master code is 1-2-3-4.

Backup Keys: Included backup manual keys are provided to unlock the unit if the battery dies.

To unlock LifePod® XR, simply open the protective cover at the front of LifePod® XR (Fig 03 on page 01), insert one of the backup keys, and turn the key clockwise 90 degrees. **IMPORTANT!** The manual key can not lock LifePod® XR.

Biometric Scanner: Capable of storing up to 20 unique fingerprints.

Simply scan an authorized fingerprint to unlock LifePod® XR. No need to wake up LifePod® XR. When the scan is authorized, the Status LED will turn GREEN and the lock will disengage. Your safe can store 20 unique fingerprint IDs. The 1st and 2nd fingerprints will be recognized as administrative fingerprints and will be used to authorize additional users (3-20).

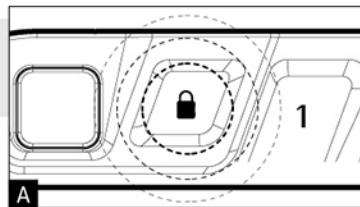

Basic Operation: Locking

With a 9V battery installed, you can now lock your XR safe. To lock, simply press and hold the lock pad for 2 seconds (Fig A on page 03).

Tip! Your XR can protect your belongings against the elements using the side compression latches alone. For extra security, lock the unit with the lock pad as needed.

IMPORTANT! Before locking your XR, always be sure the side compression latches are latched closed first. This will ensure the locking mechanism engages properly.

Basic Operation: How Your LifePod® XR Keeps People Out

Anti-Impact Latch: Built to withstand forceful impacts.

High Impact Polymer: Engineered to be extremely strong and impact resistant.

Anti-Pry Design: The interior channels and gasket form a seal around the inner chamber making it difficult for tools and other small objects to penetrate.

Security Tether: An included security cable can be used to secure LifePod® XR to a stationary object.

Security Sleep Mode: Activates when (6) consecutive incorrect keypad or fingerprint entries are entered. LifePod® XR will not accept any entries for four minutes. If a key is pressed during this time, the Status LED will flash RED and the alarm beeps. A backup key can be used to open the unit.

Warnings

To prevent damage to your LifePod® XR or injury to yourself or to others, read the following safety precautions before using this unit.

IMPORTANT! Before locking your LifePod® XR, always be sure the side compression latches are latched closed first. This will ensure the locking mechanism engages properly.

IMPORTANT! Do not undo the compression latches until the unit has been unlocked with the correct master code first. Undoing the compression latches first may cause binding on the lock mechanism and will not unlock.

LifePod® XR is designed to protect against dust and splashes with brief short immersions and will float when loaded with weight up to 27lbs.

LifePod® XR can be submerged to 1 foot up to 30 minutes.

To ensure proper weather sealing:

ALWAYS check that the rubber gasket is free of debris before closing the lid.

ALWAYS check that the side compression latches are fully engaged and closed.

ALWAYS check that the front rubber cover is closed tightly.

DO NOT expose to extreme heat or cold. Battery power may be affected. Acceptable operation range is -14° f to 120° f.

DO NOT store loaded firearms in this unit.

Disclaimers:

Neither seller nor manufacturer shall be liable for any injury, loss or damage, direct or consequential, arising out of the use of, or the inability to use, the Vaultek® LifePod® XR.

The user shall determine the suitability of the Vaultek® LifePod® XR before the intended use and user assumes all risk and liability whatsoever in connection therewith.

Battery Installation

LifePod® XR is powered by a 9v Alkaline battery (not included). Under normal use the battery can last up to one year.

- 1 Undo both side compression latches to open your LifePod® XR.
- 2 Locate the battery cover on the front wall and remove by pressing on the outer tab (Fig B).
- 3 Pull out the 9v battery snap inside the battery compartment, and connect an Alkaline 9V battery to the connector. Be sure to snap the battery in the correct orientation (Fig C).
- 4 When the battery is snapped in you will hear a short welcome tone and the keypad will light up.

Troubleshooting! If you snap the battery in and the keypad is flashing then your battery is likely low. Replace the battery with a new 9v Alkaline battery. We recommend a brand name battery like Duracell or Energizer.

- 5 Once you hear the tone and see the keypad light up, slide the battery into its compartment being mindful to place the battery ribbon underneath the battery first (Fig D). This will make the battery easier to remove when replacing.

Tip! When the unit is awake, the battery indicator on control panel will light either GREEN or RED. GREEN indicates the battery has sufficient power, and RED indicates the battery is in need of replacement.

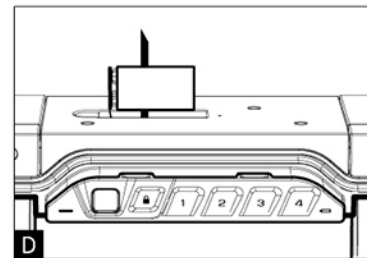
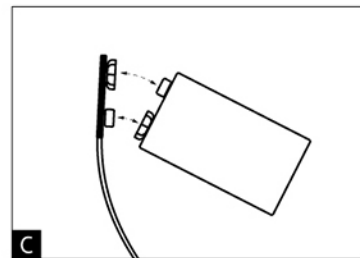
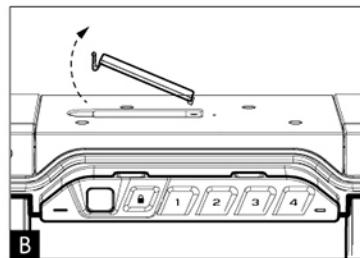

Using the Micro-USB Port

In the event the battery dies while traveling, and you do not have access to the backup keys, you can power on the unit using the backup micro-USB port.

- 1 Simply open the front protective rubber cover behind (Fig E) and plug in a micro-USB cable (not included) into the port. While the cable is plugged into an external power source, LifePod® XR will function normally allowing you to enter the code and open the unit.

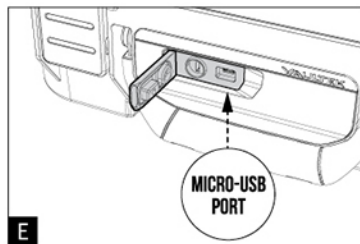

Backup Manual Key

Backup keys can not lock LifePod®XR. Backup keys are provided in case of electronic failure, allowing you to unlock LifePod®XR. The keyhole is located beneath the front protective rubber cover (Fig F).

IMPORTANT! The backup manual keys can not lock LifePod® XR.

Unlocking

- 1 To unlock LifePod®XR, simply open the protective cover (Fig F), insert one of the backup keys, and turn the key clockwise 90 degrees.

IMPORTANT! Always make sure the front protective cover is closed tightly to ensure the unit is sealed correctly for protection from the elements.

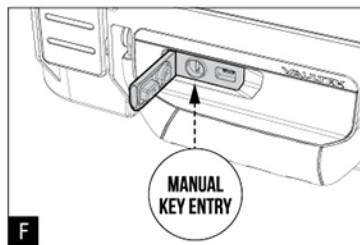

Master Code Programming

First time users should change the default code as soon as possible to prevent unauthorized access when using the lock.

Code Requirement Tips!

- The default master code is 1-2-3-4.
- Your code can be a minimum of 4 digits, or as long as 8 digits.
- Two keys can not be pressed simultaneously.
- Programming a new code will overwrite your previous code.

IMPORTANT! The PROGRAM button will not function when locked. Be sure the LifePod® XR latch is in the unlocked position.

- 1 First open the unit and tap the Lock Pad to wake the unit up (Fig G). When the keypad lights up, your LifePod® XR is awake and ready for programming.
- 2 While LifePod® XR is awake press and hold the PROGRAM button for 3 seconds (Fig H) until ALL keys (1-4) turn solid RED.
- 3 Enter your new code. Immediately press and hold the PROGRAM button a second time for 3 seconds (Fig H) until ALL keys (1-4) turn solid RED.
- 4 Enter your new code a second time. Immediately press and hold the PROGRAM button a third time for 3 seconds (Fig H). The Status LED (Fig I) will flash GREEN and LifePod® XR will beep to confirm the code change is successful.

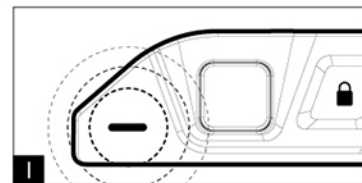
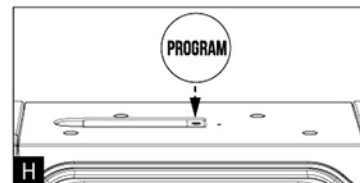
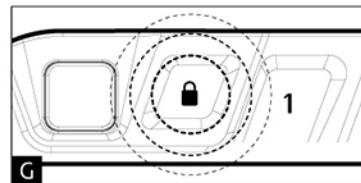

Biometric Scanner: Overview and Tips!

The safe is capable of storing fingerprint data for up to 20 unique authorized users. A user consists of 4 scans of the same finger during registration. Once a user's fingerprint data is stored in the safe and encrypted, it cannot be copied or stolen. The 1st and 2nd fingerprints will be recognized as administrative fingerprints and are required to authorize enrolling additional users (3-20).

Helpful Programming Tips!

- **Place the core of the fingerprint flat** (Fig J+K+L) over the center of the scanner (this allows the scanner to read where most of the fingerprint detail is located) see (Fig J).
- Rotate your finger slightly between registration scans to store print variations for increased accuracy (Fig K).
- Excessive moisture, lotions, or dirt will affect your fingerprint and may cause inaccurate sensor reading.
- **Troubleshooting!** If you are having difficulty with your print, program the same fingerprint 4 or 5 times. You have 20 slots available for programming and you can also try your thumb as it has more surface area to read.

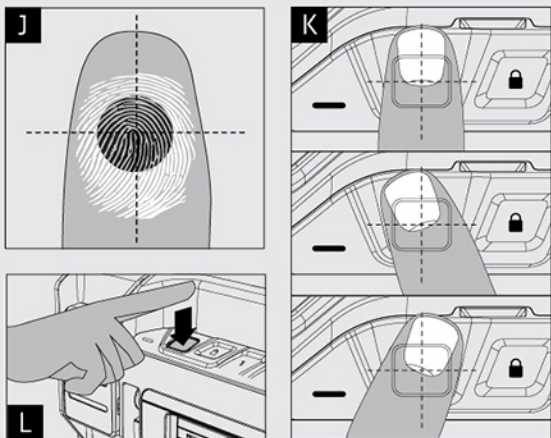

Usage Tip! The scanner is waterproof just like the LifePod® XR. However, if the scanner is wet it needs to be dried off before a finger is scanned.

For setup, tutorials, and FAQs visit www.vaulteksafe.com/support/ and select your model.

Biometric Scanner: Programming Admin Print 1 and 2

The 1st and 2nd fingerprints will be recognized as administrative fingerprints and are required to authorize enrolling additional users (3-20). To program additional users refer to the next page.

- 1 First open the unit and tap the Lock Pad to wake the unit up (Fig M). When the keypad lights up, your LifePod® XR is awake and ready for programming. Programming each fingerprint takes 4 registration scans.
- 2 Registration Scan 1: While LifePod® XR is awake, quickly tap the PROGRAM button (Fig N) to get the 1 key blinking. Place your finger on the scanner and remove it when the Status LED (Fig O) turns GREEN and you hear a confirmation beep.
- 3 Registration Scan 2: With the 2 key now blinking, place same finger on the scanner at a slightly different angle and remove it when the Status LED turns GREEN and you hear a confirmation beep.
- 4 Registration Scan 3: With the 3 key now blinking, place same finger on the scanner at a slightly different angle and remove it when the Status LED turns GREEN and you hear a confirmation beep.
- 5 Registration Scan 4: With the 4 key now blinking, place same finger on the scanner at a slightly different angle and remove it when the Status LED turns GREEN and you hear a confirmation beep. **This completes enrollment for the first admin print.**

Tip! Repeat steps 1-5 to enroll the 2nd admin print. To program prints (3-20) refer to page 11.

Troubleshooting! Reference the troubleshooting tip on page 09.

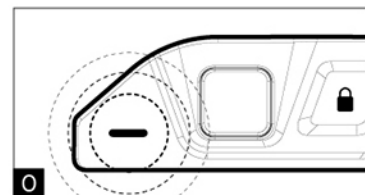
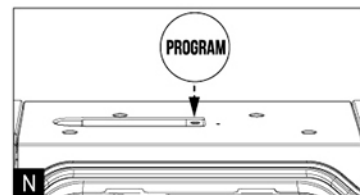
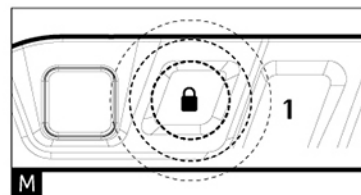

Biometric Scanner: Programming Additional Prints 3-20

With both admin prints enrolled, you can enroll additional users. This safe can store up to a total of 20 different fingerprints.

- 1 Open the safe lid, and wake LifePod® XR by tapping the Lock Pad (Fig P) so all the keys light up RED. While LifePod® XR is awake, quickly tap the PROGRAM button (Figure Q) to get keypad flashing RED. This is prompting the scan of an admin print to authorize the request to enroll a new user. Scan one of the enrolled admin prints to authorize enrolling a new user.
- 2 Registration Scan 1: With the 1 key now blinking, place the new finger on the scanner and remove it when the Status LED (Fig R) turns GREEN and you hear a confirmation beep.
- 3 Registration Scan 2: With the 2 key now blinking, place the same finger on the scanner at a slightly different angle and remove it when the Status LED turns GREEN and you hear a confirmation beep.
- 4 Registration Scan 3: With the 3 key now blinking, place the same finger on the scanner at a slightly different angle then remove it when the Status LED turns GREEN and you hear a confirmation beep.
- 5 Registration Scan 4: With the 4 key now blinking, place the same finger on the scanner at a slightly different angle then remove it when the Status LED turns GREEN and you hear a confirmation beep. This completes enrollment for a new single user.

Repeat steps 1-5 to enroll additional prints.

Troubleshooting! Reference the troubleshooting tip on page 09.

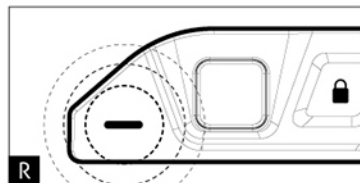
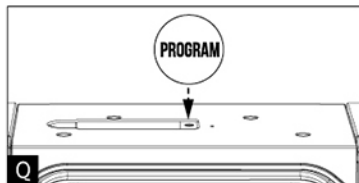
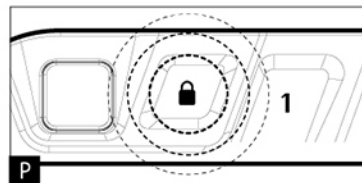

Biometric Scanner: Deleting Fingerprints

Individual fingerprints can not be deleted. Following this procedure will erase all of the fingerprints including both administrative fingerprints. This procedure will not affect the keypad master code.

- 1 To delete all the stored prints on the LifePod® XR wake the unit by tapping the Lock Pad (Fig P) so all the keys light up RED. Immediately, press and hold keys '1' and '3' together for 3 seconds (until all the keys turn RED) then enter your master code to delete all fingerprint IDs.

Biometric Scanner: Low Success Rate

If you are having difficulty with your print, program the same fingerprint 4 or 5 times. You have 20 slots available for programming and you can also try your thumb as it has more surface area to read.

- 1 Let's delete the fingerprints and start over. Wake the unit up by tapping the Lock Pad (Fig P) so all the keys light up RED. Immediately, press and hold keys 1 and 3 together for 3 seconds (until all the keys turn RED) then enter your master code to delete all fingerprint IDs.
- 2 Now let's try reprogramming your fingerprint using the helpful tips on page 09.
- 3 Open the safe. Program the 1st admin fingerprint by tapping the Lock Pad to wake the unit up (Fig P).
- 4 While LifePod® XR is awake, quickly tap the PROGRAM button (Fig Q).
- 5 When the 1 key starts blinking place your finger on the fingerprint scanner for the 1st of four scans. When the safe beeps and the 1 key lights up GREEN remove your finger.
- 6 Rotate your finger position and place your finger on the scanner. You will repeat this until all keys are solid GREEN.
- 7 Lock the safe and test to see if the safe will opens using your fingerprint.

Tip! Program the same fingerprint 4 or 5 times. You have 20 slots available for programming.

LED Indicators

LifePod's capacitive keypad has multiple LEDs built in to provide various feedback. The LEDs will illuminate as needed when the unit is awake. To wake the unit, tap the lock pad.

Status LED (Fig S) The Status LED will provide feedback on various commands. It will light GREEN when correct codes are entered or an authorized fingerprint is scanned (biometric model) and RED when an incorrect code is entered or an unauthorized fingerprint is scanned.

Tamper Indication (Fig S) If the Status LED is solid RED when awake, this means the unit has detected that an incorrect code has been entered or an unauthorized fingerprint has been scanned (biometric model). You can clear the tamper indicator by entering the correct master code or scanning an authorized fingerprint.

Lock Pad (Fig T) The Lock Pad illuminates RED only when the unit has been locked using the keypad, and requires the use of the master code or fingerprint scanner (biometric model) to unlock it. When locked, and the unit is awake, the lock icon will be solid RED.

Battery Indicator (Fig U) When the unit is awake, the battery indicator will light either GREEN or RED. GREEN indicates the battery has sufficient power, and RED indicates the battery is in need of replacement.

Low Battery Warning (Fig U) The battery indicator will flash RED and sound several rapid beeps. This continues every 5 minutes until the battery dies to indicate the battery is in need of a replacement.

Tip! If the Lock Pad icon is solid RED, do not undo the side compression latches to open the unit. This means the internal lock is engaged and should not be opened. Enter the master code or scan a fingerprint to unlock the unit, as indicated by the Lock Pad icon light going OFF. It is now safe to undo the side latches and open the unit.

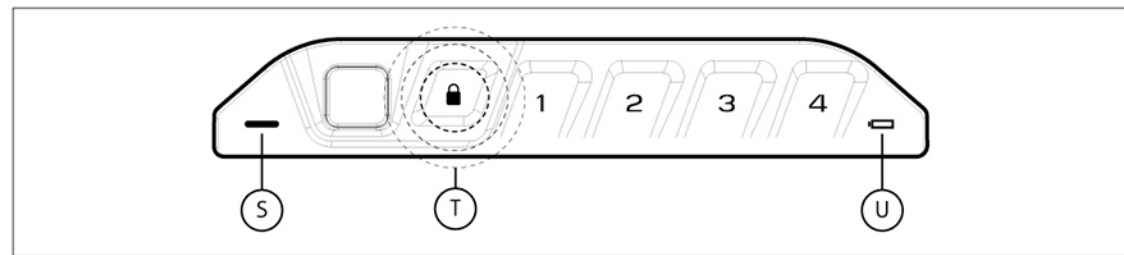

Hot Keys to Control Sound and Light

Toggle Interior LED Light ON/OFF: The Interior LED light will come on when the lid is open and stays on for about 20 seconds by default. You have the option to disable the light, or extend the light to stay on longer. To toggle the interior LED light options you need to wake up LifePod® XR by tapping the center Lock Pad (Fig T) then press and hold keys '1' and '4' together. The Status LED (Fig S) will indicate the selected light setting per below:

Tip! If toggled ON the LED may significantly reduce the battery life.

Status LED Solid RED: Interior Light is Off

Status LED Solid GREEN: Interior Light stays on for 20 seconds.

Status LED Flashing Green: Interior Light stays on for 60 seconds.

Toggle Sound ON/OFF: By default, the sound is ON. To toggle the sound ON/OFF you need to wake up LifePod® XR by tapping the center Lock Pad (Fig T) then press and hold keys '2' and '3' together. The Status LED (Fig S) will flash RED indicating OFF or GREEN indicating ON.

Compression Latches

LifePod's side compression latches can protect belongings from environmental factors using the side latches alone without the need for a battery.

To Open simply lift from the bottom of each latch away from the unit. The latches will lift and disengage, then swing the latches free of the unit. The top lid can now be opened.

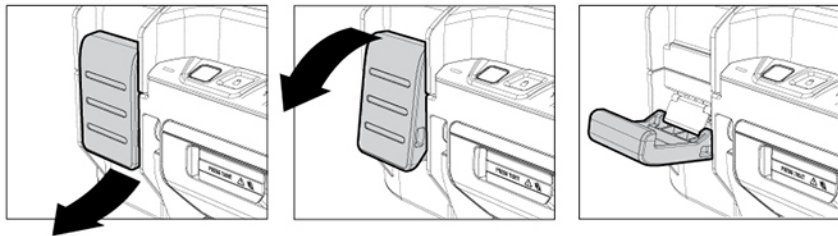

To Close rest the top of each latch against the top housing. The latches will catch and rest in place on their own. Press the bottom of each latch firmly towards the unit to engage. You will hear and feel the latches snap in position.

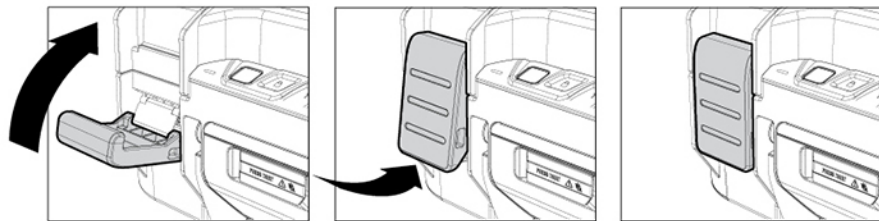

Securing your LifePod® XR

Included is a steel security cable to secure the LifePod® XR to a fixed object.

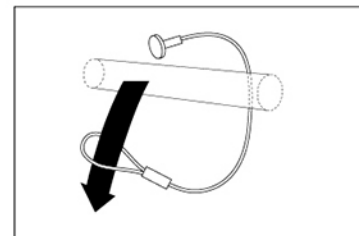

- 1 First wrap the looped end of the security cable around an object of your choice, such as a seat bracket under your car seat.

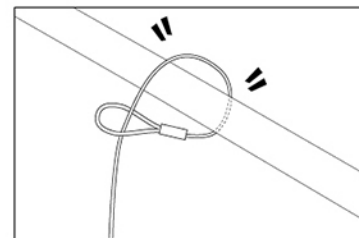

- 2 Pull the adapter piece through the loop, and cinch tight.

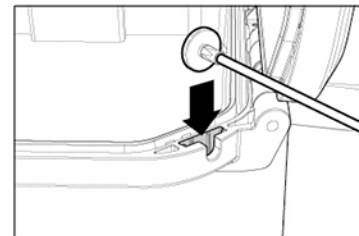

- 3 Place the adapter piece in its slot in the LifePod® XR, and close the lid.

Product Registration

Vaultek® strongly encourages you to register your LifePod® XR as soon as you receive it. **Registration provides many benefits including two year warranty, technical support, and ordering replacement keys should you misplace them.** Your Vaultek® LifePod® XR has a unique product number on the inside of the battery door and a 5 or 6 digit ID number engraved on the keys. You will need these numbers to register your new unit.

- 1 Locate your product number. It is printed on the first page of this user manual and on the back of the battery door (Fig V).
- 2 Find your 5 or 6 digit ID number engraved on the keys (Fig W).
- 3 Please visit the Vaultek® website at vaulteksafe.com and click Support then click Registration from the available options.
- 4 Enter the required information in the form and click submit.

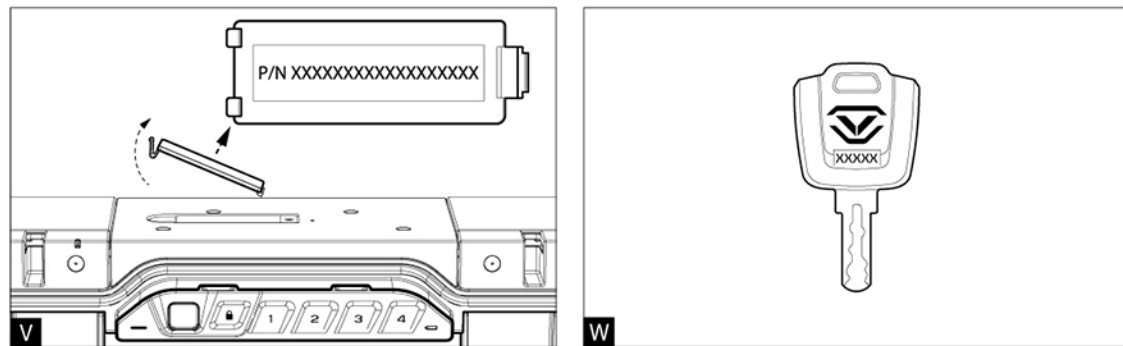

For setup, tutorials, and FAQs visit www.vaulteksafe.com/support/ and select your model.

FAQ

If you have any questions about your Vaultek® LifePod® XR or need help configuring the system, please visit www.vaulteksafe.com/support/ and or email our support team at support@vaulteksafe.com.

Why isn't the lid opening?

A) If the lid does not open, release the pressure by opening the front keyhole cover and the lid can freely open. B) If the lid does not open when unlocked, close both compression latches and unlock the unit again to free the lock mechanism.

How to lock LifePod® XR?

First shut the lid and close compression latches. Then press and hold lock icon for 3 seconds.

How to unlock LifePod® XR?

Unlock with master code/scanner or the manual key first. Undo the compression latches second.

What do I do if the keypad is flashing RED after installing the battery?

Your battery is likely low. Replace the battery with a new 9v Alkaline battery. We recommend a brand name battery like Duracell or Energizer.

How come my backup keys CAN NOT lock LifePod® XR?

LifePod's backup keys are designed to unlock in the event of an electrical failure, but they can not lock LifePod® XR.

How do I turn the sound off?

By default, the sound is ON. To toggle the sound ON/OFF you need to wake up LifePod® XR by tapping the center Lock Pad then press and hold keys '2' and '3' together. The Status LED will flash RED indicating OFF or GREEN indicating ON.

STOP! Do not return to retailer. If you have any questions about your Vaultek® safe or need help configuring the system, please email us at support@vaulteksafe.com.

For setup, tutorials, and FAQs visit www.vaulteksafe.com/support/ and select your model.

Troubleshooting

If you have any questions about your Vaultek® LifePod® XR or need help configuring the system, please visit www.vaulteksafe.com/support/ and or email our support team at support@vaulteksafe.com.

Unable to Open:

Unlock with master code/scanner or the manual key first. Undo the compression latches second.

Unable to Open:

If the lid does not open, release the pressure by opening the front keyhole cover and the lid can freely open.

Unable to Open:

Do not undo the compression latches until is unlocked. If the lid does not open when unlocked, close both compression latches and unlock the unit again to free the lock mechanism.

Unable to Lock:

First shut the lid and close compression latches. Then press and hold lock icon for 3 seconds.

Keypad is Flashing RED:

The battery is likely bad. Test the normal function by removing the battery and plugging in a micro-USB cable to the micro-USB port. If the unit resumes normal function then the installed battery is bad. We recommend a brand name battery like Duracell or Energizer.

Keypad is Flashing RED when Programming Fingerprints:

This is prompting the scan of an admin print to authorize the request to enroll a new user. Scan one of the enrolled admin prints to authorize enrolling a new user, and then continue with the registration scans.

STOP! Do not return to retailer. If you have any questions about your Vaultek® safe or need help configuring the system, please email us at support@vaulteksafe.com.

For setup, tutorials, and FAQs visit www.vaulteksafe.com/support/ and select your model.

Keys Can Not Lock LifePod® XR:

LifePod's backup keys are designed to unlock LifePod® XR in the event the battery dies, but they can not lock LifePod® XR.

New Battery is Not Working:

Test normal function by removing the battery and plugging in a micro-USB cable to the micro-USB port to power the unit so you can unlock and replace the battery. We recommend a brand name battery like Duracell or Energizer.

Unable to Program the Master Code:

The PROGRAM button will not function when locked. Be sure the LifePod® XR latch is in the unlocked position then follow the programming steps on page 08.

Low Fingerprint Success Rate:

If you are having difficulty with your print, program the same fingerprint 4 or 5 times. You have 20 slots available for programming and you can also try your thumb as it has more surface area to read. Reference page 09 for additional fingerprint tips.

STOP! Do not return to retailer. If you have any questions about your Vaultek® safe or need help configuring the system, please email us at support@vaulteksafe.com.

For setup, tutorials, and FAQs visit www.vaulteksafe.com/support/ and select your model.

Customer Support

If you have a problem with your Vaultek® LifePod® XR that is not answered in the troubleshooting section of this manual, we encourage you to visit www.vaulteksafe.com/support/ or email our support team at support@vaulteksafe.com.

Limited Warranty (Terms and Conditions)

VAULTEK® IS COMMITTED TO PROVIDING PRODUCTS OF HIGH QUALITY AND VALUE AND MAKES EVERY EFFORT TO ENSURE ITS PRODUCTS ARE FREE OF DEFECTS.

Vaultek® guarantees your LifePod® XR will be free of defects in materials or workmanship for a period of one year from the date of original purchase from an authorized dealer and two years with product registration.

The warranty is only valid for the original purchaser and not transferable. This warranty is only valid for products purchased and operated in the U.S. This warranty does not cover abuse, misuse, use in any manner for which is not designed, neglected, modification, damage inadvertently caused by the user, accidents and/or tampering.

If service is needed Vaultek® XR will, at its option, exchange or repair without charge for parts or labor. Upon authorization of warranty service, customers are responsible for securely packaging product. Additionally, customers are responsible for costs of shipping to and from Vaultek® XR service center.

If the claimed defect cannot be identified or reproduced, customers will be held responsible for the costs incurred. Please have the following information available before you begin a claim with Vaultek® XR:

- Purchaser's name, mailing address, email address, and a phone number.
- Copy of receipt or online order number (if purchased directly from us or Amazon)
- Authorized Dealer Name (if applicable)
- Detailed description of the problem

NEITHER SELLER NOR MANUFACTURER SHALL BE LIABLE FOR ANY INJURY, LOSS OR DAMAGE, DIRECT OR CONSEQUENTIAL, ARISING OUT OF THE USE OF, OR THE INABILITY TO USE THE VAULTEK® LIFEPOD® XR.

FCC This device complies with part 15 of the FCC rules. Operation is subject to the following two conditions:

(1) this device may not cause harmful interference, and (2) this device must accept any interference received, including interference that may cause undesired operation. NOTE: The manufacturer is not responsible for any radio or TV interference caused by unauthorized modifications or changes to this equipment. Such modifications or changes could void the user's authority to operate the equipment.



VAULTEK®

37 North Orange Ave. Suite 770 Orlando, FL 32801

VAULTEKSAFE.COM