



BLUETOOTH + BIOMETRIC

LifePod[®]

H U M I D O R

QUICK SETUP!

SCAN CODE ▶

*USE PHONE CAMERA



or visit www.vaulteksafe.com/support/

Thank You

At Vaultek® we stand behind our product and you our customer. On behalf of the entire team thank you for your purchase. We believe personal defense should be handled seriously and we're excited for you to experience the ultimate performance in smart-security.

Quick Start Guide

| | | | |
|---------------|-------------------------------|---------------|---|
| Step 1 | Season Humidor (05) | Step 4 | Master Code Programming (08) |
| Step 2 | Install Humidor Battery (06) | Step 5 | Biometric Scanner Programming (09 / 11) |
| Step 3 | Install LifePod® Battery (07) | Step 6 | Product Registration (12) |

Table of Contents

| | | | |
|---------|--------------------------|---------|------------------------------------|
| 01 / 02 | Get to Know Your Humidor | 17 / 18 | LED Indicators |
| 03 / 04 | Basic Operations | 19 | Hot Keys |
| 05 / 12 | Quick Start Guide | 20 / 22 | Using Humidor |
| 13 | Warnings | 23 | Securing Your LifePod® |
| 14 | Using the Micro-USB Port | 23 | Cigar Strap Removal |
| 14 | Backup Key Access | 24 | FAQ |
| 15 | Compression Latches | 25 | Troubleshooting |
| 16 | Anti-Picking | 26 | Customer Support / Warranty |

Get to Know your Humidor 2.0

Get to know your Vaultek® LifePod® Humidor 2.0.

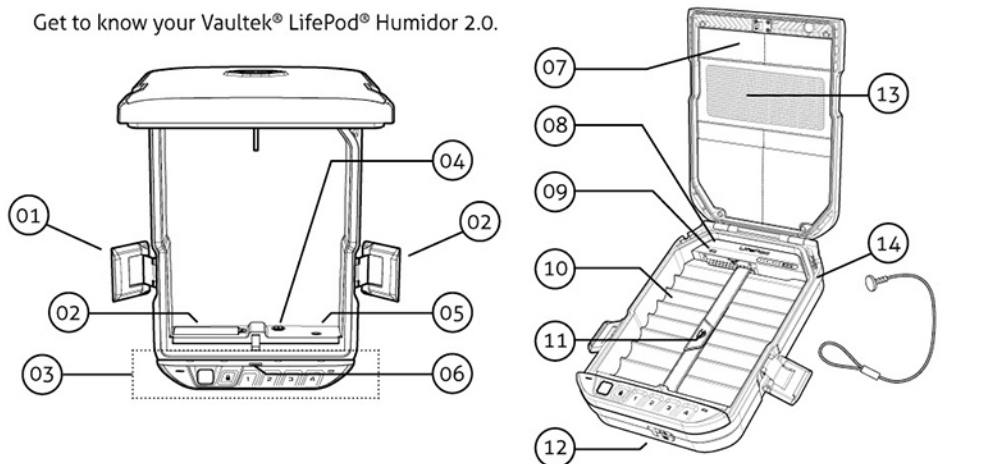

- 01. Side Compression Latches
- 02. Battery Cover
- 03. Capacitive Keypad
- 04. Anti-Picking
- 05. Program Button

- 06. Interior LED Light
- 07. Anti-Impact Latch
- 08. Bluetooth Module
- 09. LED Status
- 10. Spanish Cedar Cigar Tray

- 11. Cigar Strap
- 12. Keyhole/Micro-USB Cover
- 13. Humidity Packet Mesh Pocket
- 14. Steel Security Cable Attachment

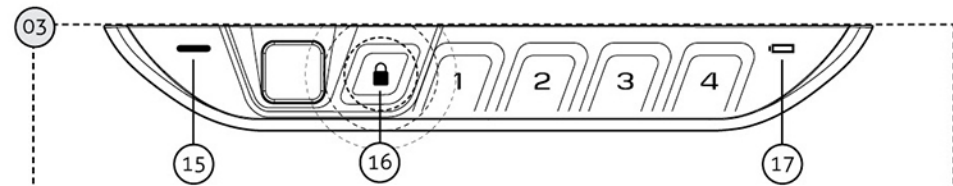

TOUCH THE LOCK PAD (13) TO WAKE THE SAFE TO ENTER MASTER CODE OR WHEN PROGRAMMING.

LifePod's capacitive keypad has multiple LEDs built in to provide various feedback. The LEDs will illuminate as needed when the unit is awake. To wake the unit, tap the lock pad.

- 15. Status LED
- 15. Tamper Indication

- 16. Lock Pad
- 17. Battery Indicator

- 17. Low Battery Warning

Box Contents

LifePod® Humidor | Lid Organizer | Bluetooth Humidor w/ Cigar Tray | (2) Backup Keys | Steel Security Cable | User Guide

For setup, tutorials, and FAQs visit www.vaulteksafe.com/support/

Basic Operations: How your Vaultek® LifePod® keeps people out

Anti-Impact Latch: Built to withstand forceful impacts.

High Impact Polymer: Engineered to be extremely strong and impact resistant.

Anti-Pry Design: The interior channels and gasket form a seal around the inner chamber making it difficult for tools and other small objects to penetrate.

Security Tether: An included security cable can be used to secure LifePod® to a stationary object.

Security Sleep Mode: Activates when (6) consecutive incorrect keypad or fingerprint entries (biometric model) are entered. LifePod® will not accept any entries for four minutes. If a key is pressed during this time, the status LED will flash RED and the alarm beeps. A backup key can be used to open the unit.

Basic Operations: Locking

LifePod® can protect belongings from environmental factors using the side compression latches alone without the need for a battery. With the battery installed LifePod® can lock securely using a built-in locking mechanism for additional security. Unique to LifePod® is a capacitive keypad. There are no physical buttons, but each key can be pressed by touching the keypad surface.

IMPORTANT! Before locking your LifePod®, always be sure the side compression latches are latched closed first. This will ensure the locking mechanism engages properly.

To lock, simply press and hold the lock pad for 2 seconds (Fig. A on page 04).

Basic Operations: Unlocking

With a 9V battery installed, you can now unlock your LifePod® safe. Unique to LifePod® is a capacitive numeric keypad with built-in proximity sensor.

IMPORTANT! Before entering your master code or when programming you need to wake the safe by placing your finger on the lock pad (Fig. A) so all the keys light up RED.

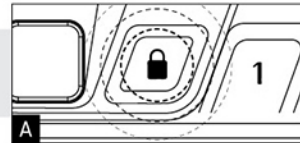

IMPORTANT! Do not undo the compression latches until the unit has been unlocked with the correct master code first. Undoing the compression latches first may cause binding on the lock mechanism and will not unlock.

Master Code: Touch activated 4-digit backlit LED capacitive keypad. First tap the lock pad to wake the unit up. When the keypad lights up, your LifePod® is awake and ready to accept the code. Enter your master code. When the code is correct, the status LED will turn GREEN and the lock will disengage. Default master code is 1-2-3-4.

Backup Keys: Included backup manual keys are provided to unlock the unit if the battery dies. To unlock LifePod®, simply open the protective cover at the front of LifePod® (Fig 12 on page 01), insert one of the backup keys, and turn the key clockwise 90 degrees. If the Anti-Picking feature is enabled, the backup keys can not open LifePod®. **IMPORTANT** The manual key can not lock LifePod®.

Biometric Scanner (Biometric Model Only): Capable of storing up to 20 unique fingerprints. Simply scan an authorized fingerprint to unlock LifePod®. **No need to wake up LifePod®.** When the scan is authorized, the status LED will turn GREEN and the lock will disengage. Your safe can store 20 unique fingerprint IDs. The 1st and 2nd fingerprints will be recognized as administrative fingers and will be used to authorize additional users (3-20).

Quick Start Guide

Follow the quick start guide to get your LifePod® up and running. If you have any questions or issues please email support@vaulteksafe.com.

Season Humidor

Quick Start Guide Step 1

We recommend seasoning Humidor once you receive it.

Tip! Boveda makes 60 gram seasoning packs that can be found online or in many cigar shops.

- 1 Remove the cedar tray from your LifePod (Fig. B).
- 2 Place the cedar tray in an airtight container or zip-lock bag along with an 84% seasoning pack for 14 days.
- 3 Reinstall the cedar tray back inside your LifePod and place a humidity control pack with your preferred %RH inside the control pack pocket on the lid.

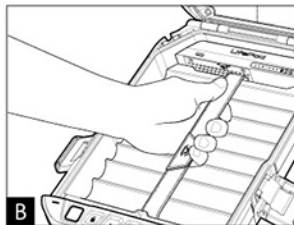

You can purchase Boveda packs here:
<https://store.bovedainc.com/collections/boveda-for-tobacco>

Tip! We recommend reseasoning your Humidor once a year.

For setup, tutorials, and FAQs visit www.vaulteksafe.com/support/

Install Humidor Battery

Quick Start Guide Step 2

LifePod® Humidor is powered by **(2)** 9v Alkaline batteries (not included). One powers the Bluetooth Humidor, and the second powers the LifePod's built-in locking system.

- 1 Undo both side compression latches to open your LifePod®. Using the strap, gently lift the interior module out (Fig. B).
- 2 Locate the battery cover on the reverse side (Fig. C), and remove by pressing on the outer tab.
- 3 Pull out the 9v battery snap and connect one of the included Alkaline 9v batteries.
- 4 Slide the battery into the compartment and replace the cover.

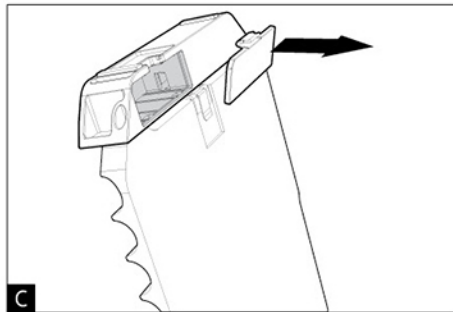

TIP! Refer to page 20 for more information including using the Vaultek® LifePod® Humidor app.

For setup, tutorials, and FAQs visit www.vaulteksafe.com/support/

Install LifePod® Battery

Quick Start Guide Step 3

- 1 Remove the cedar tray and locate the battery cover on the front wall of the LifePod® and remove it by pressing on the outer tab (Fig. D).
- 2 Carefully pull out the 9v battery snap inside the battery compartment, and connect an Alkaline 9V battery (not included) to the connector. Be sure to snap the battery in the correct orientation (Fig. E).
- 3 When the battery is snapped in you will hear a short welcome tone and the keypad will light up.
- 4 Once you hear the tone and see the keypad light up, slide the battery ribbon underneath the battery first (Fig. F). This will make the battery easier to remove when replacing.
- 5 Replace the battery cover, replace the cedar tray back inside, and you are ready to program your LifePod®.

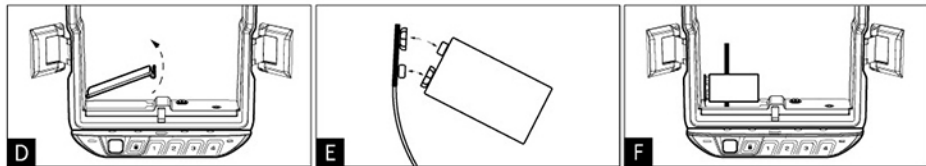

Master Code Programming

Quick Start Guide Step 4

First time users should change the default code as soon as possible to prevent unauthorized access when using the lock.

TIP: Code Requirements

- The default master code is 1-2-3-4.
- Your code can be a minimum of 4 digits, or as long as 8 digits.
- Two keys can not be pressed simultaneously.
- Programming a new code will overwrite your previous code.

IMPORTANT! The PROGRAM button will not function when locked. Be sure the LifePod® latch is in the unlocked position.

- 1 First open the unit and tap the lock pad to wake the unit up (Fig G). When the keypad lights up, your LifePod® is awake and ready for programming.
- 2 While LifePod® is awake press and hold the PROGRAM button for 3 seconds (Fig. H) until ALL keys (1-4) turn solid RED.
- 3 Enter your new code. Immediately press and hold the PROGRAM button a second time for 3 seconds (Fig. H) until ALL keys (1-4) turn solid RED.
- 4 Enter your new code a second time. Immediately press and hold the PROGRAM button a third time for 3 seconds (Fig. H). The status LED (Fig. I) will flash GREEN and LifePod® will beep to confirm the code change is successful. If you make a mistake start over with step 1.

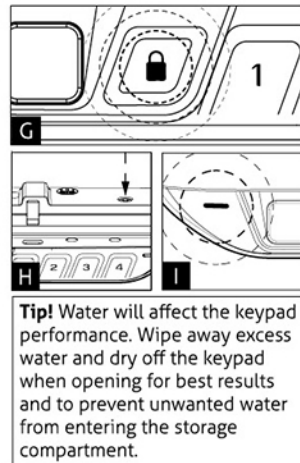

Tip! Water will affect the keypad performance. Wipe away excess water and dry off the keypad when opening for best results and to prevent unwanted water from entering the storage compartment.

The safe is capable of storing fingerprint data for up to 20 unique authorized users. A user consists of 4 scans of the same finger during registration. Once a user's fingerprint data is stored in the safe and encrypted, it cannot be copied or stolen. The 1st and 2nd fingerprints will be recognized as administrative fingerprints and are required to authorize enrolling additional users (3-20).

Helpful Programming Tips!

- **Place the core of the fingerprint flat** (Fig J + K + L) over the center of the scanner (this allows the scanner to read where most of the fingerprint detail is located) see (Fig J).
- Rotate your finger slightly between registration scans to store print variations for increased accuracy (Fig L).
- Excessive moisture, lotions, or dirt will affect your fingerprint and may cause inaccurate sensor reading.
- **Troubleshooting!** If you are having difficulty with your print, program the same fingerprint 4 or 5 times. You have 20 slots available for programming and you can also try your thumb as it has more surface area to read.

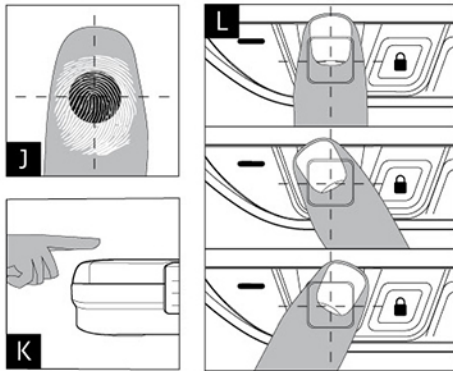

Usage Tip! The scanner is waterproof just like the LifePod®. However, if the scanner is wet it needs to be dried off before a finger is scanned.

Your safe can store 20 unique fingerprint IDs. The 1st and 2nd fingerprints will be recognized as administrative fingerprints and will be used to authorize additional users (3-20).

- 1 First open the unit and tap the lock pad to wake the unit up (Fig. G on page 08). When the keypad lights up, your LifePod® is awake and ready for programming. Programming each fingerprint takes 4 registration scans.
- 2 Registration Scan 1: While LifePod® is awake, quickly tap the PROGRAM button (Fig. H page 08) to get the 1 key blinking. Place your finger on the scanner and remove it when the status LED turns GREEN and you hear a confirmation beep.
- 3 Registration Scan 2: With the 2 key now blinking, place same finger on the scanner at a slightly different angle and remove it when the status LED turns GREEN and you hear a confirmation beep.
- 4 Registration Scan 3: With the 3 key now blinking, place same finger on the scanner at a slightly different angle and remove it when the status LED turns GREEN and you hear a confirmation beep.
- 5 Registration Scan 4: With the 4 key now blinking, place same finger on the scanner at a slightly different angle and remove it when the status LED turns GREEN and you hear a confirmation beep.
This completes enrollment for the first admin print.

Tip! Simply scan an authorized fingerprint to unlock LifePod®. No need to wake up LifePod®.

Tip! Repeat steps 1-5 to enroll the 2nd admin print. To program prints (3-20) refer to page 11.

With both admin prints enrolled, you can enroll additional users. This safe can store up to a total of 20 different fingerprints.

- 1 Open the safe lid, and wake LifePod® by tapping the lock pad so all the keys light up RED. While LifePod® is awake, quickly tap the PROGRAM button to get keypad flashing RED. This is prompting the scan of an admin print to authorize the request to enroll a new user. Scan one of the enrolled admin prints to authorize enrolling a new user.
- 2 Registration Scan 1: With the 1 key now blinking, place the new finger on the scanner and remove it when the status LED turns GREEN and you hear a confirmation beep.
- 3 Registration Scan 2: With the 2 key now blinking, place the same finger on the scanner at a slightly different angle and remove it when the status LED turns GREEN and you hear a confirmation beep.
- 4 Registration Scan 3: With the 3 key now blinking, place the same finger on the scanner at a slightly different angle then remove it when the status LED turns GREEN and you hear a confirmation beep.
- 5 Registration Scan 4: With the 4 key now blinking, place the same finger on the scanner at a slightly different angle then remove it when the status LED turns GREEN and you hear a confirmation beep. This completes enrollment for a new single user.

Repeat steps 1-5 to enroll additional prints.

Vaultek® strongly encourages you to register your safe as soon as you receive it. **Registration provides many benefits including technical support, and ordering replacement keys should you misplace them.** Your Vaultek® LifePod® has a unique product number on the inside of the battery door and a 4-digit ID number engraved on the keys. You will need these numbers to register your new unit.

- 1 Locate your product number. It is printed on the first page of this user manual and on the back of the battery door (Fig. M).
- 2 Find your 4-digit ID number engraved on the keys (Fig. N).
- 3 Please visit the Vaultek® website at vaulteksafe.com and click Support then click Registration from the available options.
- 4 Enter the required information in the form and click submit.

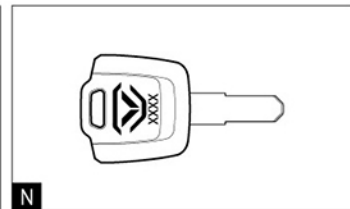
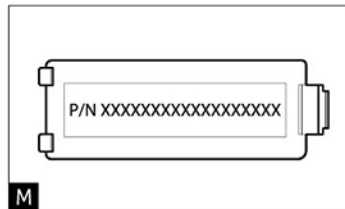

Warnings

To prevent damage to your LifePod® or injury to yourself or to others, read the following safety precautions before using this unit.

IMPORTANT Before locking your LifePod®, always be sure the side compression latches are latched closed first. This will ensure the locking mechanism engages properly.

IMPORTANT Do not undo the compression latches until the unit has been unlocked with the correct master code first. Undoing the compression latches first may cause binding on the lock mechanism and will not unlock.

DO NOT submerge in water more than 1 foot deep. The pressure could leak water into the inner chamber. LifePod® is designed to protect against dust and splashes with brief short immersions and will float when loaded with weight up to 2lb.

DISCLAIMERS: Neither seller nor manufacturer shall be liable for any injury, loss or damage, direct or consequential, arising out of the use of, or the inability to use, the Vaultek® LifePod®.

The user shall determine the suitability of the Vaultek® LifePod® before the intended use and user assumes all risk and liability whatsoever in connection therewith.

The Bluetooth® word mark and logos are registered trademarks owned by the Bluetooth SIG, Inc. and any use of such marks by Vaultek Safe, Inc. is under license.

To ensure proper weather sealing:

ALWAYS check that the rubber gasket is free of debris before closing the lid

ALWAYS check that the side compression latches are fully engaged and closed

ALWAYS check that the front rubber cover is closed tightly

DO NOT expose to extreme heat or cold. Battery power may be affected. Acceptable operation range is -14°f to 120°f.

DO NOT store loaded firearms in this unit.

Using the Micro-USB Port

A micro-USB port is built into LifePod® behind the front protective rubber cover (Fig. O).

In the event the battery dies while traveling, and you do not have access to the backup keys, you can power on the unit using the backup micro-USB port.

Simply open the rubber cover (Fig. O) and plug in a micro-USB cable (not included) into the port. While the cable is plugged into an external power source, LifePod® will function normally allowing you to enter the code and open the unit.

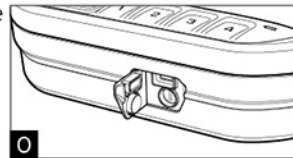

Backup Key Access

Backup keys can not lock LifePod®. Backup keys are provided in case of electronic failure, allowing you to unlock LifePod®. The keyhole is located beneath the front protective rubber cover (Fig. O).

To unlock LifePod®, simply open the protective cover (Fig. O), insert one of the backup keys, and turn the key clockwise 90 degrees. If the Anti-Picking feature is enabled, the backup keys can not open LifePod®. See page 16 for details.

IMPORTANT! Always make sure the front protective cover is closed tightly to ensure the unit is sealed correctly for protection from the elements.

Compression Latches

LifePod's side compression latches can protect belongings from environmental factors using the side latches alone without the need for a battery.

To Open simply lift from the bottom of each latch away from the unit (Fig. P). The latches will lift and disengage, then swing the latches free of the unit (Fig. Q). The top lid can now be opened.

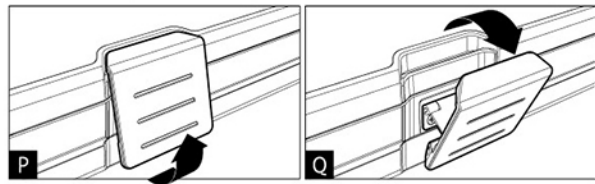

To Close rest the top of each latch against the top housing (Fig. R). The latches will catch and rest in place on their own. Press the bottom of each latch firmly towards the unit to engage (Fig. S). You will hear and feel the latches snap in position.

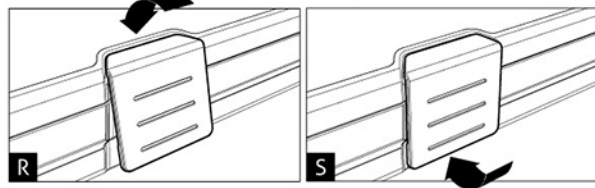

Anti-Picking

Your LifePod® is equipped with an anti-hacking feature for enhanced security. Using the Anti-Picking feature, you can disable the front key access. This prevents the front keyway from being picked open, but also prevents the lock from being opened with the manual key.

IMPORTANT! The manual key can not lock LifePod® with either setting.

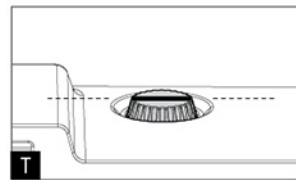

OFF (Fig. T) Default setting. Front keyway is functional, manual keys can unlock LifePod®.

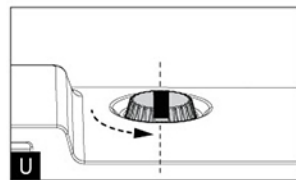

ON (Fig. U) Front keyway is disabled. LifePod® can not be picked open, and the manual keys can not be used to open the unit.



WARNING When Anti-Picking is ON, the backup keys will not be able to open the unit. Use with caution.

WARNING When Anti-Picking is ON, the backup keys will not be able to open the unit. If you forget your master code you will be unable to open LifePod®. Use with caution.

LED Indicators

LifePod's capacitive keypad has multiple LEDs built-in to provide various feedback. The LEDs will illuminate as needed when the unit is awake. To wake the unit, tap the lock pad to illuminate the keypad.

Status LED (Fig. V) The status LED will provide feedback on various commands. It will light GREEN when correct codes are entered and RED when an incorrect code is entered.

Tamper Indication (Fig. V) If the status LED is solid RED when awake, this means the unit has detected that an incorrect code has been entered. You can clear the tamper indicator by entering the correct master code.

Battery Indicator (Fig. X) When the unit is awake, the battery indicator will light either GREEN or RED. Green indicates the battery has sufficient power, and Red indicates the battery is in need of replacement.

Low Battery Warning (Fig. X) The battery indicator will flash RED and sound several rapid beeps. This continues every 5 minutes until the battery dies to indicate the battery is in need of a replacement.

For setup, tutorials, and FAQs visit www.vaulteksafe.com/support/

Lock Pad (Fig. W) The lock pad illuminates RED only when the unit has been locked using the keypad, and requires the use of the master code to unlock it. When locked, and the unit is awake, the lock icon will be solid RED.

Tip! If the lock icon is solid RED, do not undo the side compression latches to open the unit. This means the internal lock is engaged and should not be opened. Enter the master code to unlock the unit, as indicated by the lock icon light going OFF. It is now safe to undo the side latches and open the unit.

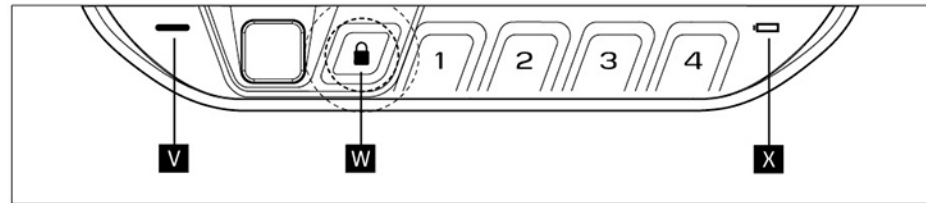

For setup, tutorials, and FAQs visit www.vaulteksafe.com/support/

Hot Keys

Toggle Interior LED Light ON/OFF: The Interior LED light will come on when the lid is open and stays on for about 20 seconds by default. You have the option to disable the light, or extend the light to stay on longer. To toggle the interior LED light options you need to wake up LifePod® by tapping the center Lock Pad (Fig. W on page 18) then press and hold keys '1' and '4' together. The status LED (Fig. V on page 18) will indicate the selected light setting per below:

Tip! If toggled ON the LED may significantly reduce the battery life.

Status LED Solid RED: Interior Light is Off

Status LED Solid GREEN: Interior Light stays on for 20 seconds.

Status LED Flashing Green: Interior Light stays on for 60 seconds.

Toggle Sound ON/OFF: By default, the sound is ON. To toggle the sound ON/OFF you need to wake up LifePod® by tapping the center Lock Pad (Fig. W on page 18) then press and hold keys '2' and '3' together. The status LED (Fig. V on page 18) will flash RED indicating OFF or GREEN indicating ON.

Deleting Fingerprints: To delete all the stored prints on the LifePod®, wake the unit by tapping the Lock Pad (Fig. W on page 18) so all the keys light up RED. Immediately, press and hold keys '1' and '3' together for 3 seconds (until all the keys turn RED) then enter your master code to delete all fingerprint IDs.

For setup, tutorials, and FAQs visit www.vaulteksafe.com/support/

Using Humidor

Bluetooth App

The LifePod® Humidor has a Bluetooth enabled interior module that monitors the internal humidity and temperature. Using the Bluetooth companion app from your smartphone, you can view live environment data when in range of the LifePod® (approximately 20-25 feet) and you can manage certain preferences.

To Get the App

Available for Android and iOS devices, search for "Vaultek LifePod Humidor" in your app store.

Setting Environmental Thresholds

Using the app, you can set environmental thresholds for your ideal interior conditions, and if the humidity or temperature values are higher or lower than desired, the app can provide feedback from the main dashboard.

Tip! The app will not send alerts to your phone, but allows you to make convenient maintenance checks when in range. The app dashboard will provide graphical indication of the values and highlight any values out of range.

For setup, tutorials, and FAQs visit www.vaulteksafe.com/support/

Using Humidor

Power Switch

When not traveling, or when monitoring is not necessary, you can switch the Bluetooth module off to save power (see Fig. Y).

This disables Bluetooth and the app functions only. This does not affect LifePod's standard functions such as locking and unlocking.

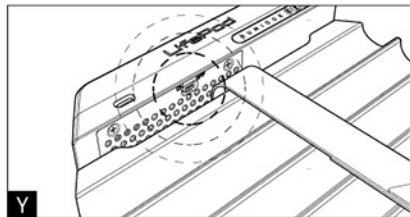

Audible Alarm

The interior module has an audible alarm that can be enabled. If any set thresholds from the app are out of range, LifePod® will sound an audible alarm to alert you.

The audible alarm will sound for any of the following reasons and can be adjusted in your settings menu in the app.

Humidity High / Humidity Low
Temperature High / Temperature Low
Low Bluetooth Module Battery (This is not the same battery that's powering the LifePod®)

Tip! If the alarm sounds, disable it from the settings menu in the app. Make any adjustments such as replacing a humidity packet or replacing the battery if needed and enable the alarm again.

Using Humidor

Maintaining Proper Humidity

LifePod® Humidor is designed to help you manage and monitor humidity levels. The included lid organizer features a mesh pocket designed to store humidity control packs. We recommend a brand name pack, such as Boveda control packs (bovedainc.com). Using a control pack with your preferred RH% in conjunction with the Bluetooth app can help you maintain optimum conditions.

Tip! Adjust the app thresholds to suit your ideal conditions. If LifePod® alerts you that humidity is high/low it may be time to replace the humidity control pack inside.

LED Status

The interior module has a status LED on the left hand side. If an audible alert is heard from the unit, the status LED can provide a quick gauge for the alert reason.

Flashing YELLOW with rapid beeps: Humidity or Temperature is Low/High
Flashing RED with rapid beeps: Low Battery

Securing Your LifePod®

The included steel security cable can be used to secure the LifePod® to a fixed object.

- 1 First wrap the looped end of the steel cable around an object of your choice, such as a seat bracket under your vehicle's seat.
- 2 Pull the adapter piece through the loop, and cinch tight.
- 3 Place the adapter piece in its slot in the LifePod®, and close the lid.

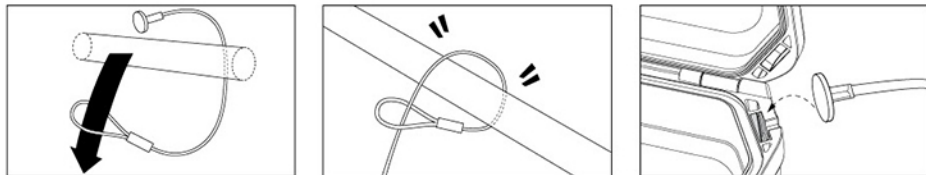

Cigar Strap Removal

The cigar straps can be removed as needed. Simply remove the cigar tray, undo the velcro straps, and slide the cigar strap down and off the end of the metal clip (Fig. Z).

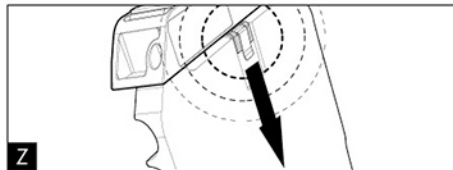

FAQ More online at vaulteksafe.com under Support

If you have any questions or issues please email support@vaulteksafe.com.

Q: What do I do if the keypad is flashing RED after installing the battery?

A: Your battery is likely low. Replace the battery with a new 9v Alkaline battery. We recommend a brand name battery like Duracell or Energizer.

Q: How come my backup keys CAN NOT lock LifePod®?

A: LifePod's backup keys are designed to unlock in the event of an electrical failure, but they can not lock LifePod®. **NOTE: Enabling the Anti-Picking feature ON, will prevent the keys from being able to unlock LifePod® as this feature disables the front keyway altogether.**

Q: Why isn't the keypad lighting up when programming the master code?

A: LifePod® must be awake when programming the unit. Tap the lock pad to get all the keys to turn red, and then resume programming.

Q: Is LifePod® fireproof or waterproof?

A: LifePod® is not fireproof, but is waterproof up to 1 foot deep. It is designed to stay afloat in the water with weight up to 2lb.

STOP! Do not return to retailer. If you have any questions about your Vaultek® Humidor or need help configuring the system, please email us at support@vaulteksafe.com.

Troubleshooting More online at vaulteksafe.com under Support

Keypad is Flashing RED: The battery is likely bad. Test the normal function by removing the battery and plugging in a micro-USB cable to the micro-USB port. If the unit resumes normal function then the installed battery is bad. We recommend a brand name battery like Duracell or Energizer.

Keypad is Flashing RED When Programming Fingerprints: This is prompting the scan of an admin print to authorize the request to enroll a new user. Scan one of the enrolled admin prints to authorize enrolling a new user, and then continue with the registration scans.

Keys Can Not Lock LifePod®: LifePod's backup keys are designed to unlock LifePod in the event the battery dies, but they can not lock LifePod®. NOTE: Enabling the Anti-picking feature ON, will prevent the keys from being able to unlock LifePod® as this feature disables the front keyway altogether.

New Battery is Not Working: Test normal function by removing the battery and plugging in a micro-USB cable to the micro-USB port to power the unit so you can unlock and replace the battery. We recommend a brand name battery like Duracell or Energizer.

Low Fingerprint Success Rate: If you are having difficulty with your print, program the same fingerprint 4 or 5 times. You have 20 slots available for programming and you can also try your thumb as it has more surface area to read.

Still Need Help? Please email our support team at support@vaulteksafe.com. They would be more than happy to help you out!

Customer Support

If you have a problem with your Vaultek® LifePod® that is not answered in the FAQ section of this manual, we encourage you to visit www.vaulteksafe.com and select Support.

Limited Warranty: Terms and Conditions

VAULTEK® IS COMMITTED TO PROVIDING PRODUCTS OF HIGH QUALITY AND VALUE AND MAKES EVERY EFFORT TO ENSURE ITS PRODUCTS ARE FREE OF DEFECTS.

Vaultek® guarantees your LifePod® will be free of defects in materials or workmanship for a period of one year from the date of original purchase from an authorized dealer.

The warranty is only valid for the original purchaser and not transferable. This warranty is only valid for products purchased and operated in the U.S. This warranty does not cover abuse, misuse, use in any manner for which is not designed, neglected, modification, damage inadvertently caused by the user, accidents and/or tampering.

If service is needed Vaultek® will, at its option, exchange or repair without charge for parts or labor. Upon authorization of warranty service, customers are responsible for securely packaging product. Additionally, customers are responsible for costs of shipping to and from Vaultek® service center.

If the claimed defect cannot be identified or reproduced, customers will be held responsible for the costs incurred. Please have the following information available before you begin a claim with Vaultek®:

- Purchaser's name, mailing address, email address, and a phone number.
- Copy of receipt or online order number (if purchased directly from us or Amazon)
- Authorized Dealer Name (if applicable)
- Detailed description of the problem

NEITHER SELLER NOR MANUFACTURER SHALL BE LIABLE FOR ANY INJURY, LOSS OR DAMAGE, DIRECT OR CONSEQUENTIAL, ARISING OUT OF THE USE OF, OR THE INABILITY TO USE THE VAULTEK® LIFEPOD®.

FCC

This device has been evaluated to meet general RF exposure requirement. The device can be used in portable exposure condition without restriction. Federal Communication Commission (FCC) Radiation Exposure Statement. Power is so low that no RF exposure calculation is need.

This device complies with part 15 of the FCC rules. Operation is subject to the following two conditions: (1) this device may not cause harmful interference, and (2) this device must accept any interference received, including interference that may cause undesired operation.

NOTE: The manufacturer is not responsible for any radio or TV interference caused by unauthorized modifications or changes to this equipment. Such modifications or changes could void the user's authority to operate the equipment.

NOTE: This equipment has been tested and found to comply with the limits for a Class B digital device, pursuant to part 15 of the FCC Rules. These limits are designed to provide reasonable protection against harmful interference in a residential installation. This equipment generates uses and can radiate radio frequency energy and, if not installed and used in accordance with the instructions, may cause harmful interference to radio communications. However, there is no guarantee that interference will not occur in a particular installation. If this equipment does cause harmful interference to radio or television reception, which can be determined by turning the equipment off and on, the user is encouraged to try to correct the interference by one or more of the following measures:

- Reorient or relocate the receiving antenna.
- Increase the separation between the equipment and receiver.
- Connect the equipment into an outlet on a circuit different from that to which the receiver is connected.
- Consult the dealer or an experienced radio/TV technician for help.



VAULTEK®

37 North Orange Ave. Suite 770 Orlando, FL 32801

VAULTEKSAFE.COM

REV 120321 AM